

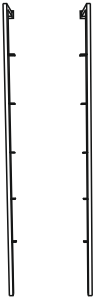

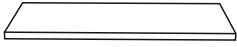



ITEM NAME / NOM D'ITEM: ZEBRA SHELF

ITEM # / NO. ITEM: 109387

PARTS LIST / LISTE DES PIÈCES

(1)	(2)	(3)					
 <p>X2</p>	 <p>X5</p>	<p>(A)</p>  <p>X10</p>	<p>(B)</p>  <p>X10</p>	<p>(C)</p>  <p>X1</p>	<p>(D)</p>  <p>X8</p>	<p>(E)</p>  <p>X8</p>	<p>(F)</p>  <p>TIPPING RESTRAINT X2</p>

ASSEMBLY INSTRUCTIONS / INSTRUCTIONS D'ASSEMBLAGE

(I) Put the Shelves (2) on the metal Legs (1)

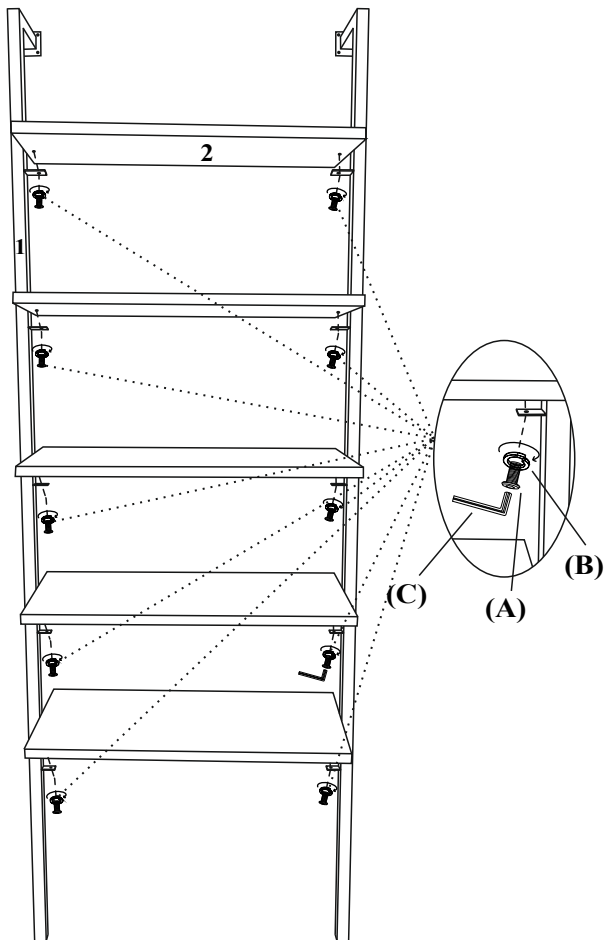

(II) Fix the Shelf on the wall by using screws.

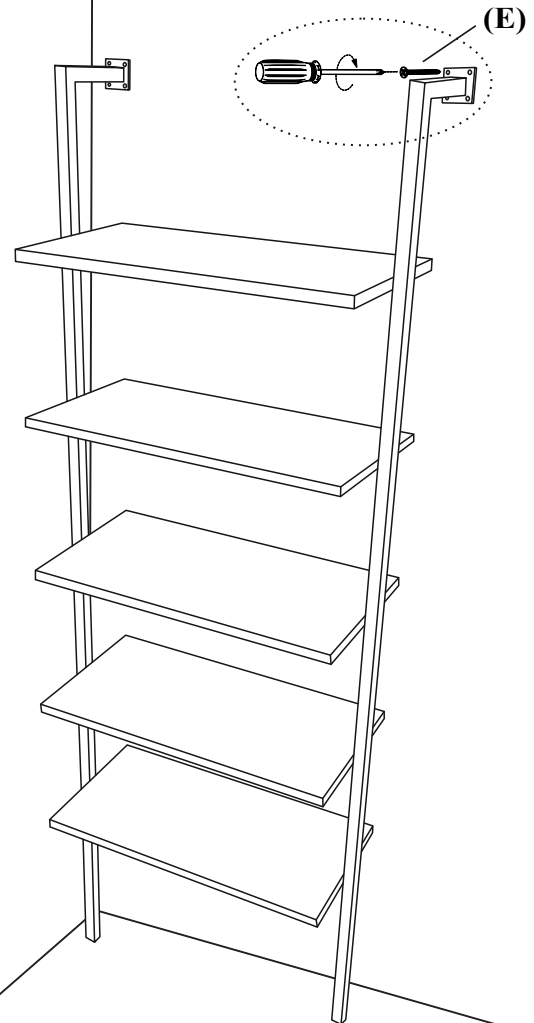

TOOLS REQUIRED

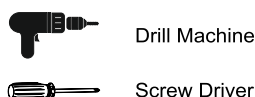

Drill the black Dot



Insert plastic Anchor (D) into the wall

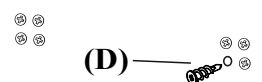

To install the furniture tipping restraint:

1. Determine the approximate location where the bookshelf will be placed. Locate a wall stud.
2. Attach one of the 'L' brackets to the wall stud using the 2" screw through the small hole in the 'L' bracket.
3. Position the bookshelf, then install the strap around the leg and through the 'L' bracket as shown.

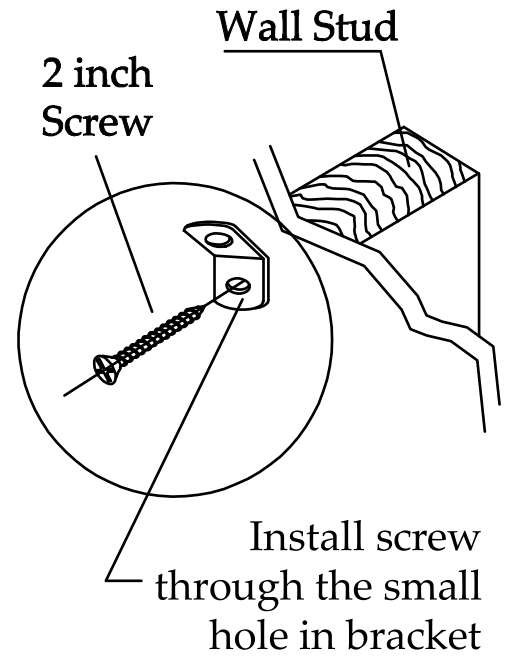

(III)

