











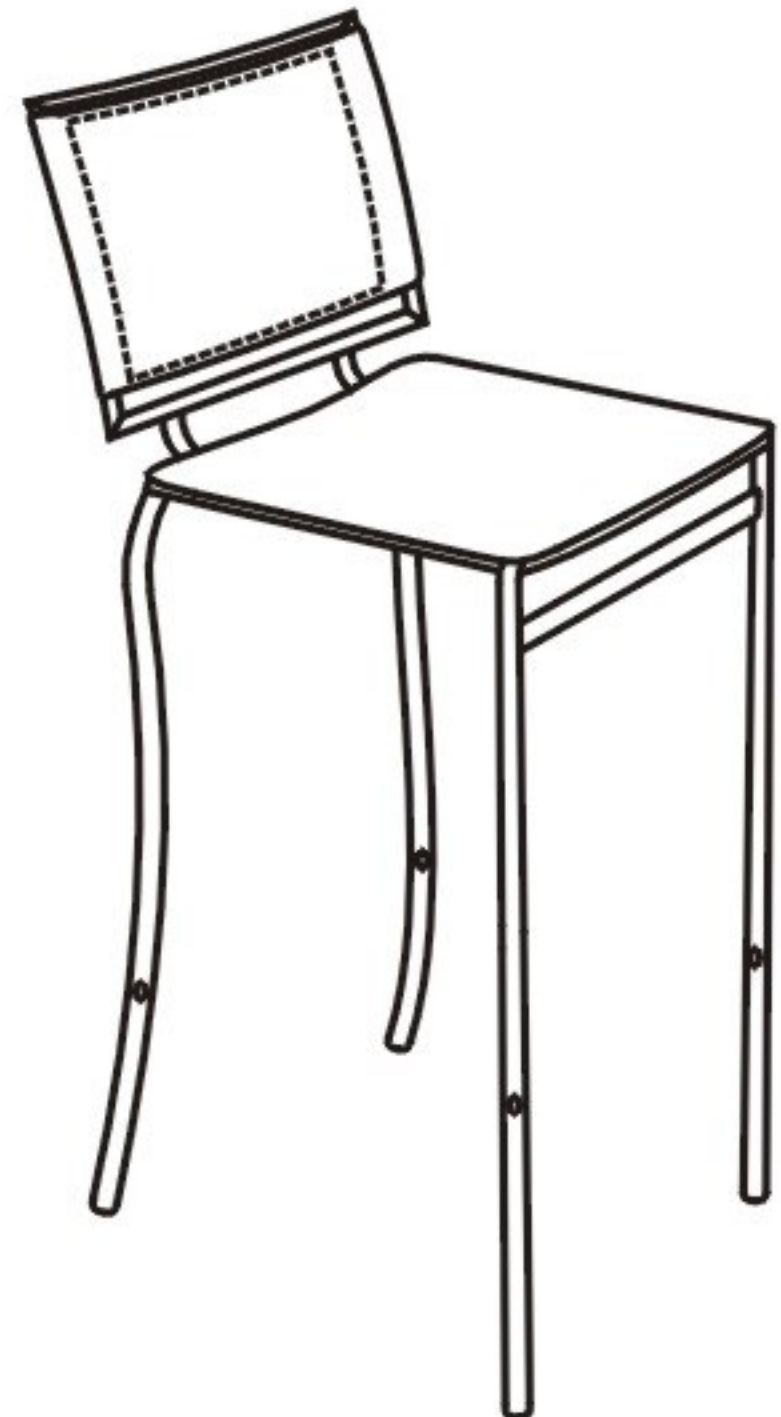
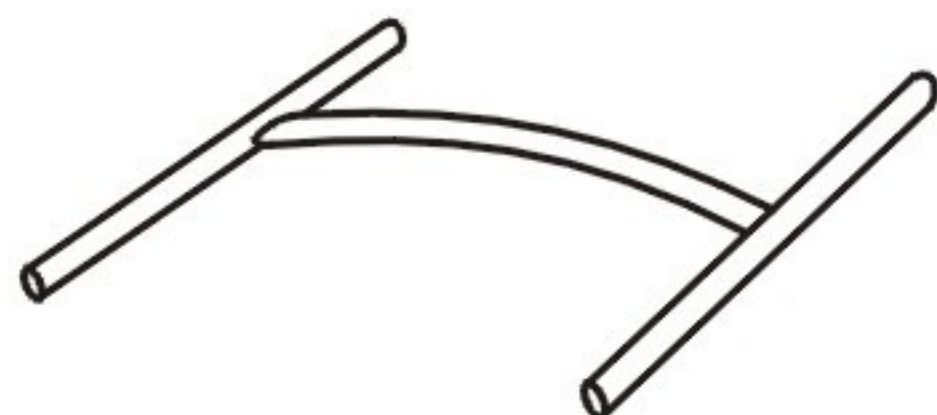







ITEM NAME /NOM D' ITEM:SOAR BAR CHAIR

ITEM # /NO. ITEM:300150 (BLACK/NOIR)

300151 (WHITE/BLANC)

Enquiry:parts@zuomod.com

PART LIST/Liste des pièces

(1)	(2)	(3)																								
 X1	 X1	<table border="0"><tr><td>1.</td><td></td><td></td><td>X4</td></tr><tr><td>2.</td><td></td><td>6*35MM</td><td>X4</td></tr><tr><td>3.</td><td></td><td></td><td>X1</td></tr><tr><td>4.</td><td></td><td>6*25MM</td><td>X2</td></tr><tr><td>5.</td><td></td><td></td><td>X4</td></tr><tr><td>6.</td><td></td><td>6*20MM</td><td>X2</td></tr></table>	1.			X4	2.		6*35MM	X4	3.			X1	4.		6*25MM	X2	5.			X4	6.		6*20MM	X2
1.			X4																							
2.		6*35MM	X4																							
3.			X1																							
4.		6*25MM	X2																							
5.			X4																							
6.		6*20MM	X2																							

INSTRUCTION

A

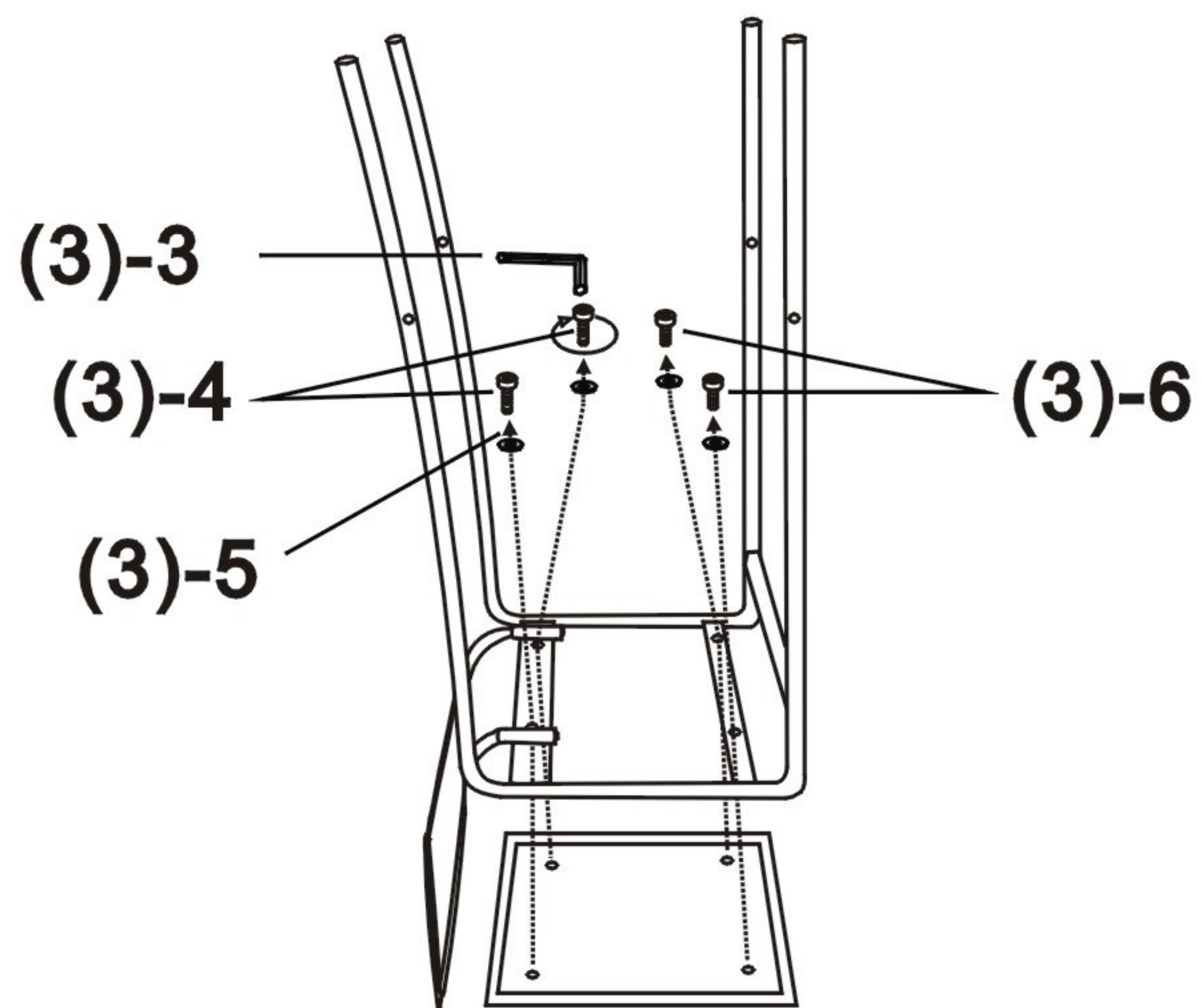

B

