

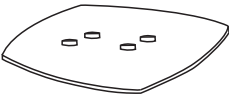

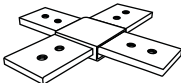





ITEM NAME /NOM D' ITEM:LEMON DROP DINNING TABLE

ITEM # /NO. ITEM:102195

Enquiry:parts@zuomod.com

PART LIST/Liste des pièces

(1)	(2)	(3)	(4)
 X1	 X1	 X4	<ol style="list-style-type: none"> X8 8X12mm X4 10X20mm X4 X4 X1 6mm X1 5mm

INSTRUCTION

A

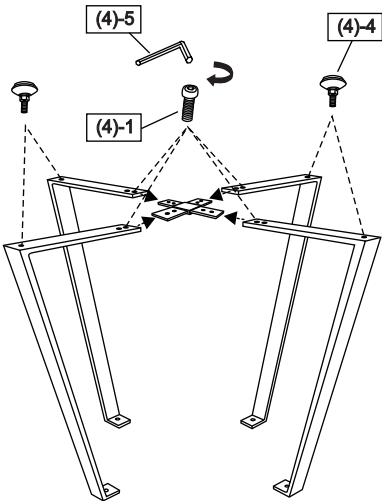

B

