









ITEM NAME/ NOM D'ITEM: ERIC OFFICE CHAIR
ITEM#/NO. ITEM: 101783/101784/101785

PART LIST / LISTE DES PIÈCES

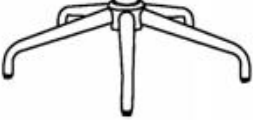
(1)	(2)	(3)	(4)
 x1	 x2	 x1	 x1
(5)	(6)	(7)	
 x1	 x5	<p>A.  M6x18mm x4</p> <p>B.  M6x32mm x8</p> <p>C.  5mm x1</p>	

ASSEMBLY INSTRUCTIONS / INSTRUCTIONS D'ASSEMBLAGE

I

REMOVE THE CAP BEFORE ASSEMBLE

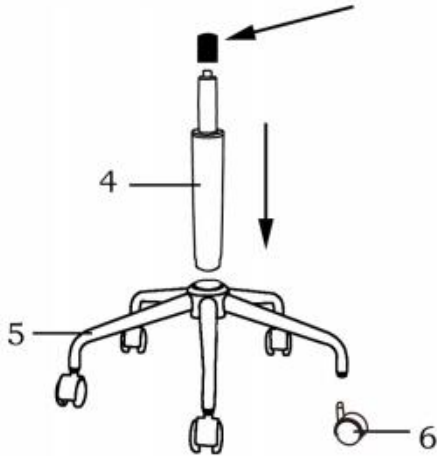

II

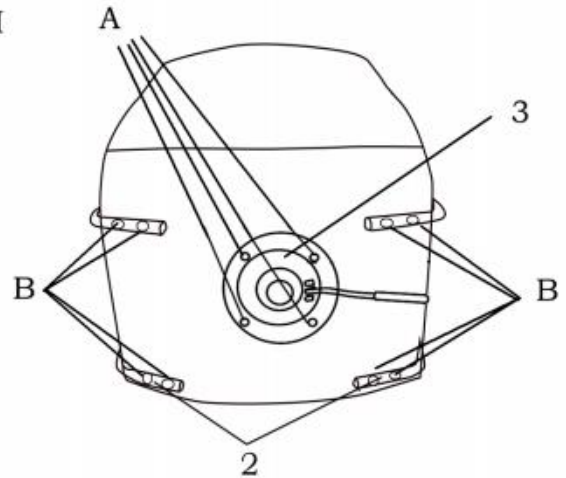

III

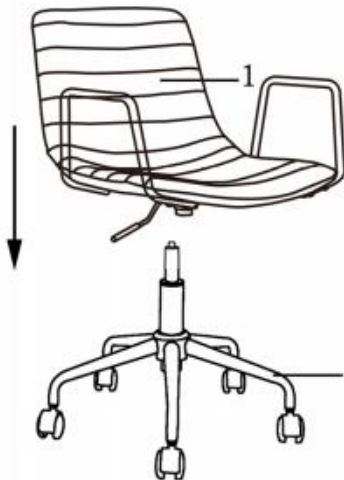

IV

