





ITEM NAME / NOM D'ITEM: PAULETTE ACCENT CHAIR
ITEM #/NO. ITEM: 101728/101729

PART LIST / LISTE DES PIÈCES

(1)	(2)	(3)	(4)
			
x1	x1	x1	x2

(5)

A.  M6x 25mm x16

B.  6mm x1

ASSEMBLY INSTRUCTIONS / INSTRUCTIONS D'ASSEMBLAGE

I

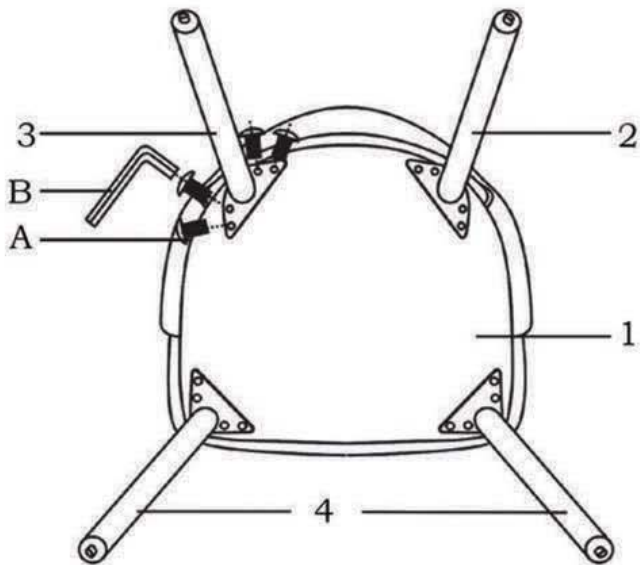

II

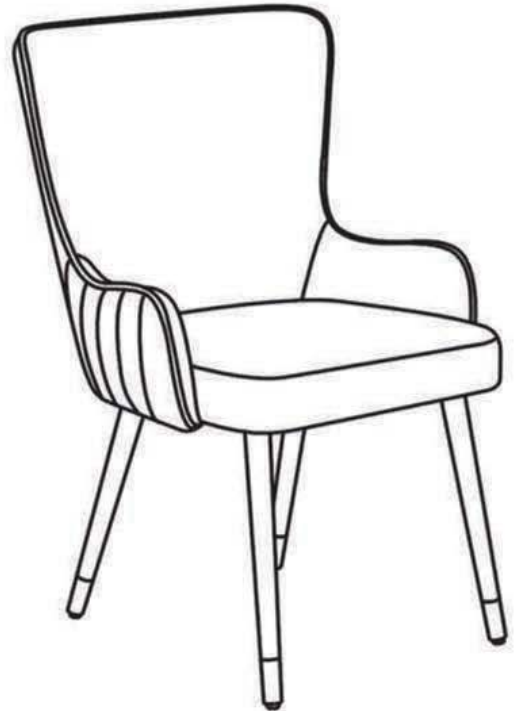

For missing parts or damaged parts, please call

USA : 1-866-798-6663
 Canada : 514-382-6661