

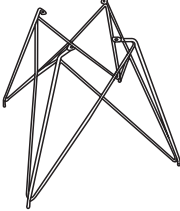



**ITEM NAME / NOM D'ITEM: PARKER DINING CHAIR**  
**ITEM #/NO. ITEM: 101712**

**PARTS LIST / LISTE DES PIÈCES**

(1)	(2)	(3)	(4)
 <p style="text-align: center;">x1</p>	 <p style="text-align: center;">x1</p>	 <p style="text-align: center;">x4</p>	<p>A.  M6x16mm x4</p> <p>B.  6mm x1</p>

**ASSEMBLY INSTRUCTIONS / INSTRUCTIONS D'ASSEMBLAGE**

I.

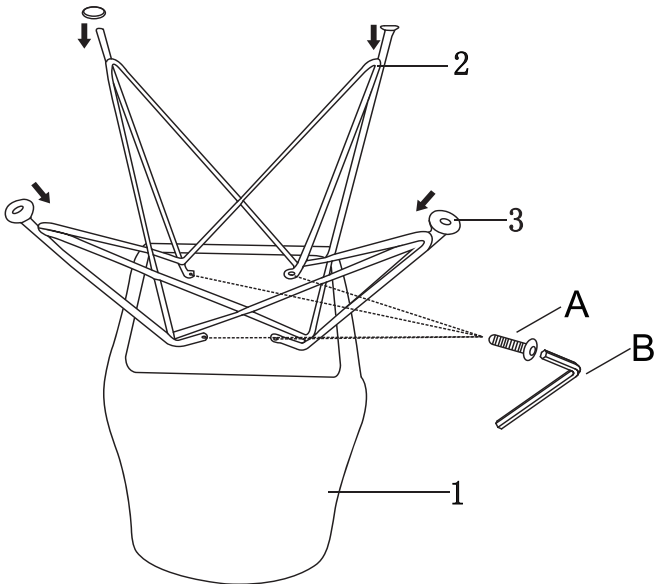

II.

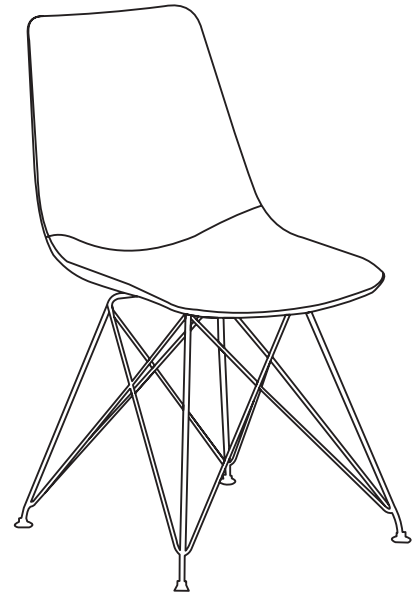

For missing parts or damaged parts, please call

USA : 1-866-798-6663

Canada : 514-382-6661

AI-2-200622