

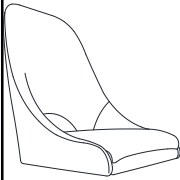

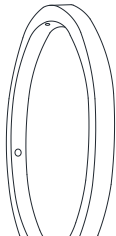
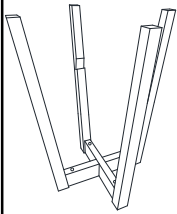
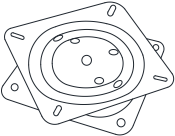
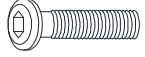

ITEM NAME/NOM D'ITEM: ASHMORE BARSTOOL

ITEM# /NO.ITEM: 101010/101011

PARTS LIST/LISTE DES PIÈCES

1	2	3	4	5
				A. BOLT JCBC M6 x 25MM  x4
x1	x1	x1	x1	B. BOLT JCBC M6 x 40MM  x8
				C. FLAT WASHER M6 x 20MM  x8
				D. SPRING WASHER M6 x 14MM  x12
				E. ALLEN KEY M4 x 65MM  x1

ASSEMBLY INSTRUCTIONS/INSTRUCTIONS D'ASSEMBLAGE

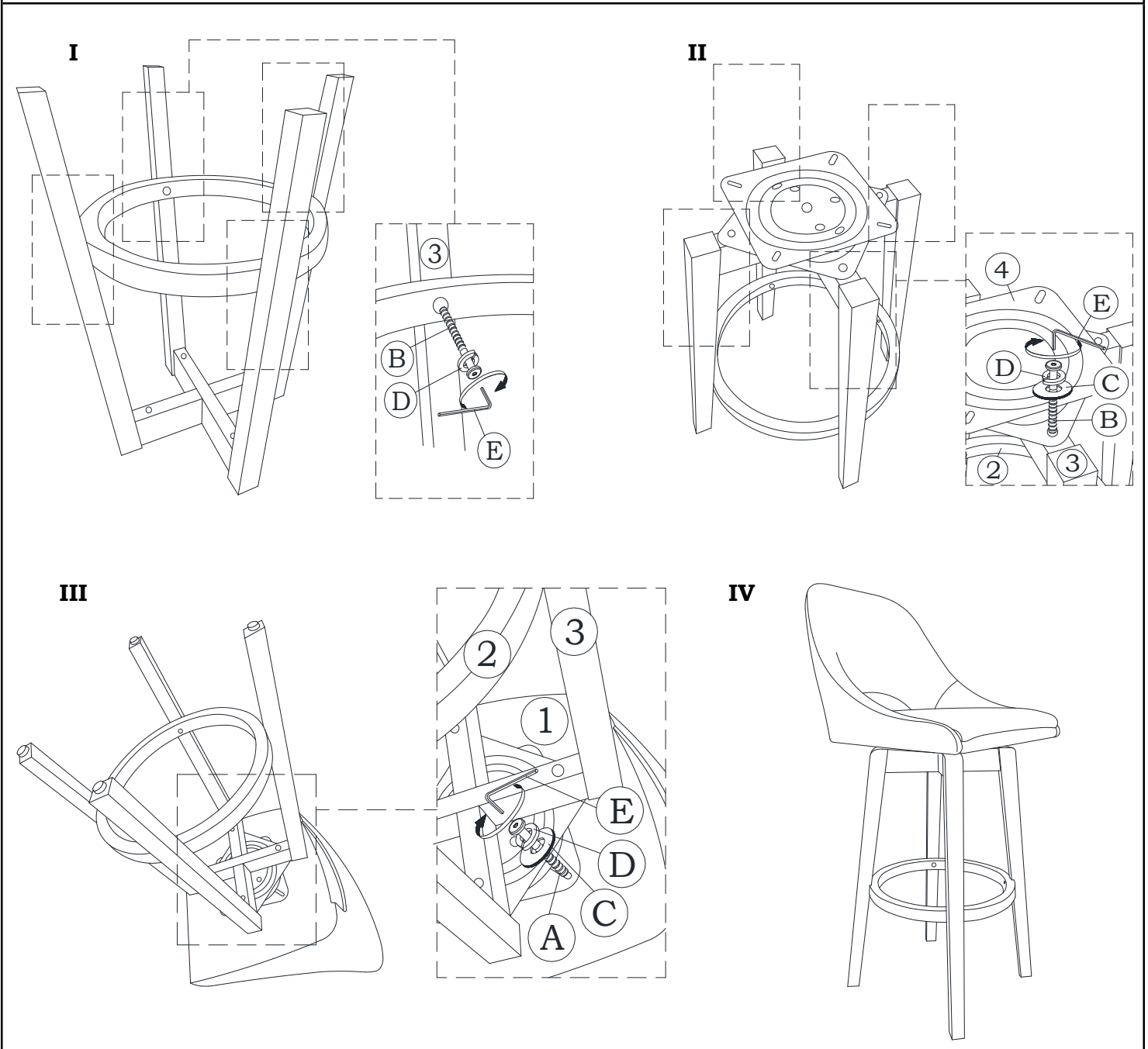

For missing parts or damaged parts, please call

USA : 1-866-798-6663

Canada : 514-382-6661