

Brand ZUCCHETTI

Class THERMOSTATIC MIXERS

JINGLE

ZT2977.1900 Built-in thermostatic shower mixer with 1 stop valve.











¾" built-in thermostatic shower mixer with 1 stop valve.

R99630.1900

Rough-in



Finishes

		C3		C8		C40		C41		C50		C51
Chrome	Brushed Nickel		Polished Nickel		Gold		Brushed Gold		Metal Black		Brushed Metal Black	
	W1		N1									
Embossed Matt White		Embossed Matt Black										

JINGLE

ZT2977.1900 Overall Drawing

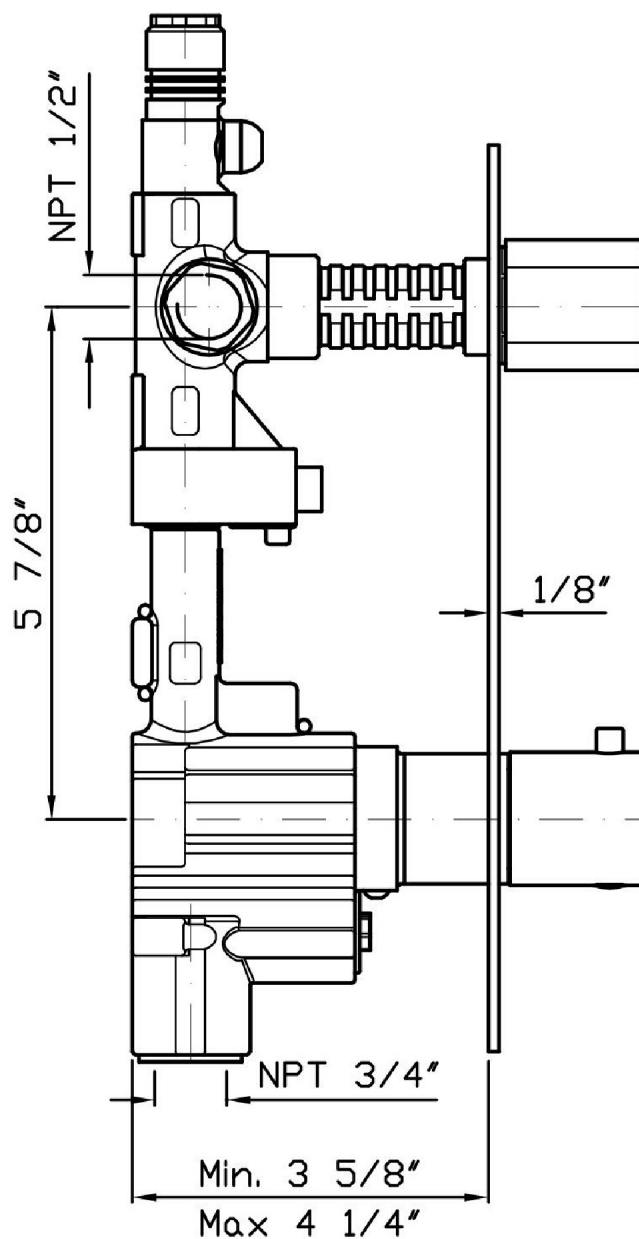
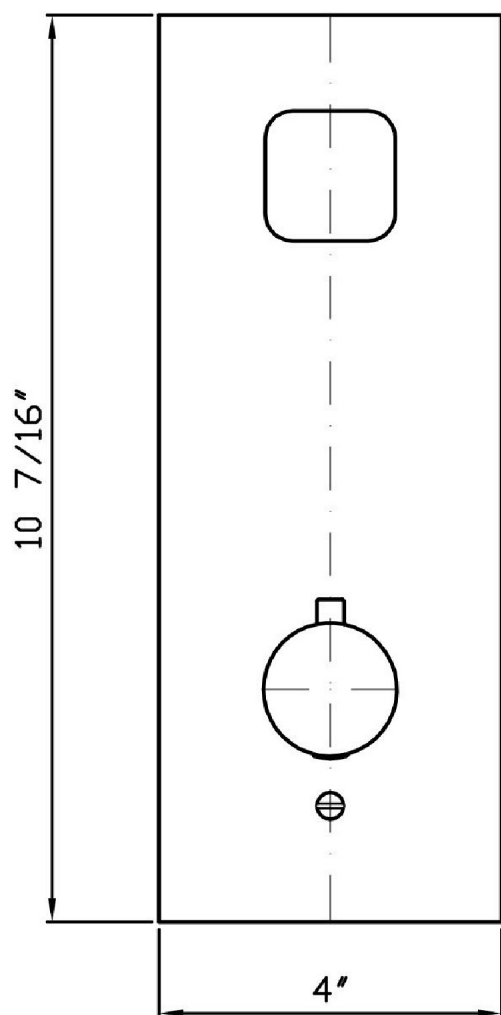

JINGLE

ZT2977.1900 Exploded

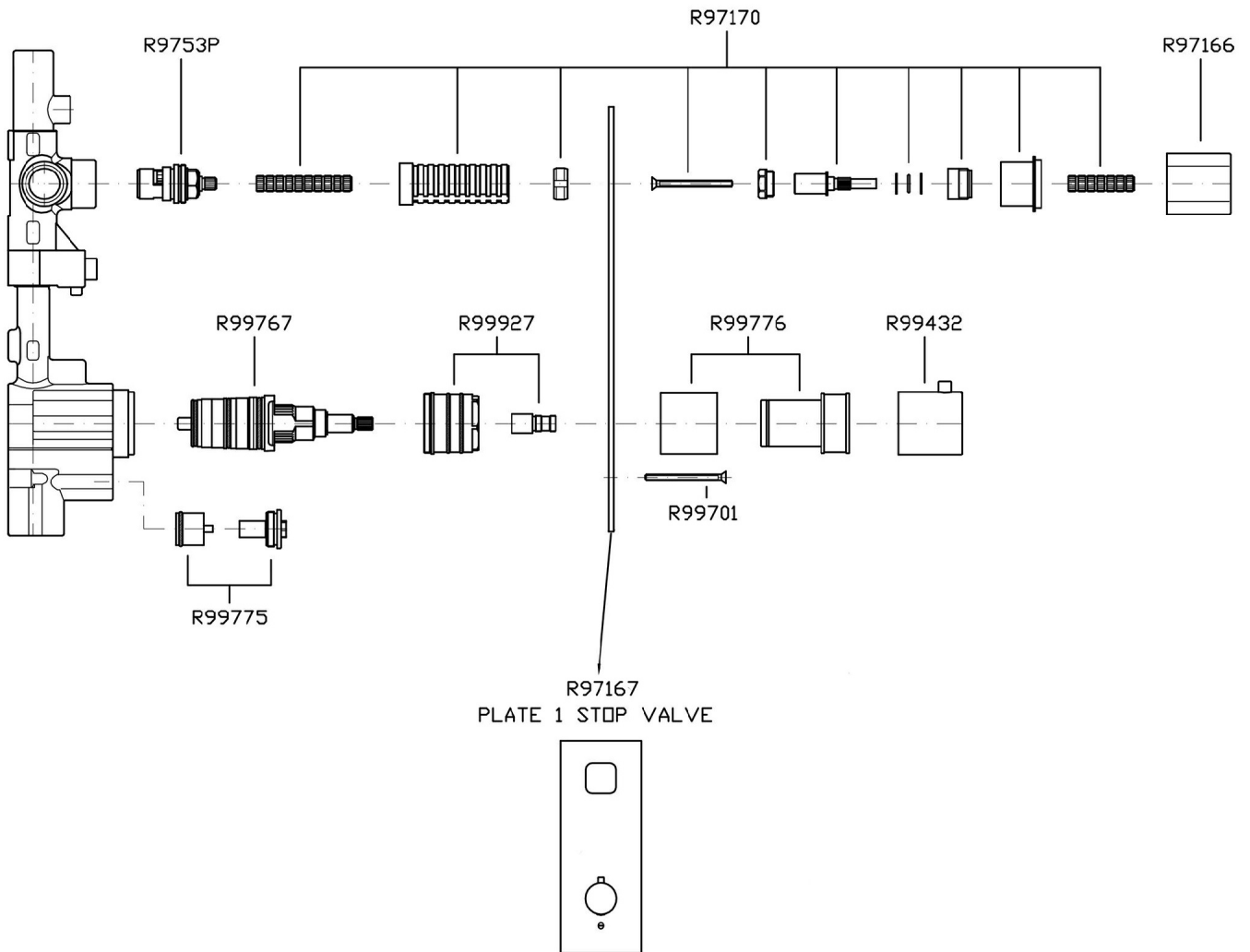

Brand ZUCCHETTI

Class

THERMOSTATIC
MIXERS

JINGLE

ZT2977.1900 Weights and Sizes

Weight (lb)	1,6 (Kg)	3,52736 (lb)
Volume (dc3) - (in3)	5,68 (dc3)	0,000347 (in3)
h (mm) - (in)	75 (mm)	2,9527575 (in)
L1 (mm) - (in)	180 (mm)	7,086618 (in)
L2 (mm) - (in)	420 (mm)	16,535442 (in)

