

Brand ZUCCHETTI

Class

SAVOIR

SAVOIR

ZSV729.1900CN Wall valve.















1/2" wall valve.

R99779.1900

Rough-in



Finishes

 CN	 CC	 CW	 GR	 CL	 CV	 C8C8
Chrome + Black	Chrome + Chrome	Chrome + White	Chrome + Red	Chrome + Blue	Chrome + Green	Polished Nickel
 C8W	 C8N	 C8R	 C8L	 C8V		
Polished Nickel+White	Polished Nickel+Black	Polished Nickel+Red	Polished Nickel+Blue	Polished Nickel+Green		

SAVOIR

ZSV729.1900CN Overall Drawing

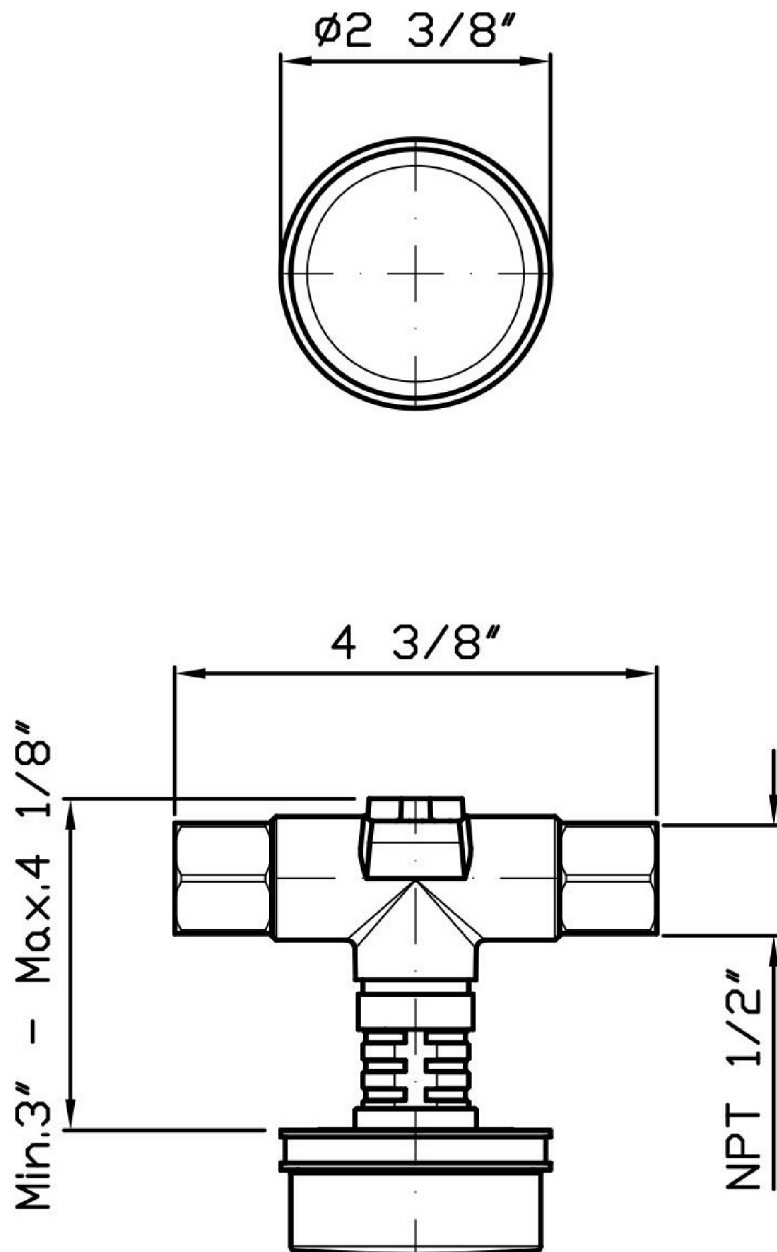

Brand ZUCCHETTI

Class

SAVOIR

SAVOIR

ZSV729.1900CN Certifications

USA

IAPMO

SAVOIR

ZSV729.1900CN Weights and Sizes

Weight (lb)	0,76 (Kg)	1,675496 (lb)
Volume (dc3) - (in3)	1,21 (dc3)	0,000074 (in3)
h (mm) - (in)	73 (mm)	2,8740173 (in)
L1 (mm) - (in)	127 (mm)	5,0000027 (in)
L2 (mm) - (in)	130 (mm)	5,118113 (in)

