

Brand ZUCCHETTI

Class

SAVOIR

## SAVOIR

ZSV671.190ECN 3 hole built-in basin mixer.















3 hole built-in basin mixer, with aerator.  
Spout projection 6 7/8".  
Water flow restricted to 1 GPM.

R99500.190E

Assembled rough-in part, interaxe 8"



### Finishes

 CN Chrome + Black	 CC Chrome + Chrome	 CW Chrome + White	 CR Chrome + Red	 CL Chrome + Blue	 CV Chrome + Green	 C8C8 Polished Nickel
 C8W Polished Nickel+White	 C8N Polished Nickel+Black	 C8R Polished Nickel+Red	 C8L Polished Nickel+Blue	 C8V Polished Nickel+Green		

Brand ZUCCHETTI

Class

SAVOIR

## SAVOIR

ZSV671.190ECN Overall Drawing

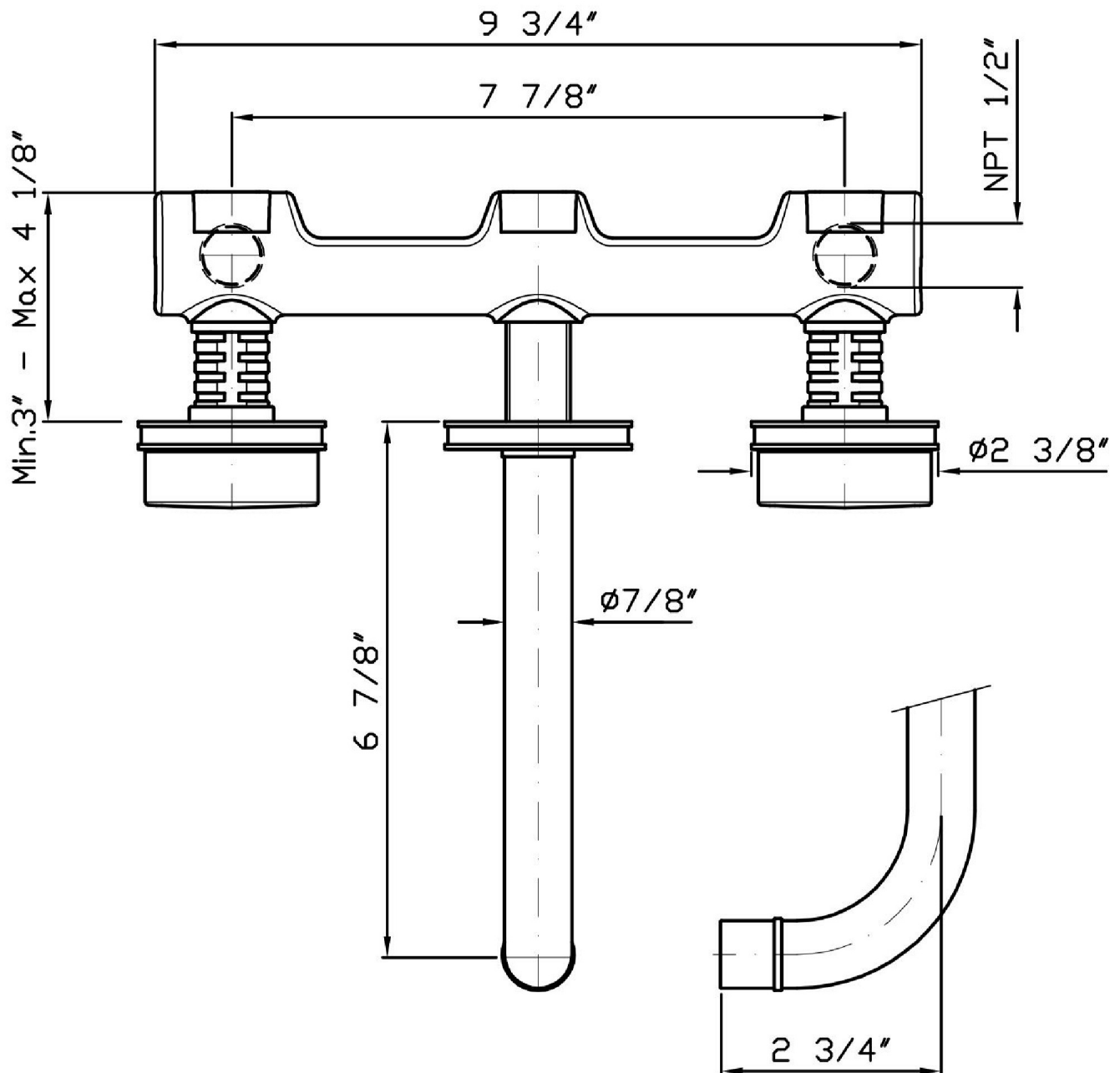

Brand ZUCCHETTI

Class

SAVOIR

## SAVOIR

### ZSV671.190ECN Certifications

USA

IAPMO

## SAVOIR

### ZSV671.190ECN Weights and Sizes

Weight ( lb )	2,35 ( Kg )	5,18081 ( lb )
Volume ( dc3 ) - ( in3 )	11,01 ( dc3 )	0,000672 ( in3 )
h ( mm ) - ( in )	90 ( mm )	3,543309 ( in )
L1 ( mm ) - ( in )	335 ( mm )	13,1889835 ( in )
L2 ( mm ) - ( in )	365 ( mm )	14,3700865 ( in )

