

Brand ZUCCHETTI

Class

SAVOIR

SAVOIR













ZSV226.CN

Exposed bath-shower mixer.



Exposed bath-shower mixer with antispash, diverter, handshower, flexible hose 59".
Spout projection 8 3/4".

Finishes

| | | | | | | |
|---|--|--|---|--|--|---|
|  CN Chrome + Black |  CC Chrome + Chrome |  CW Chrome + White |  CR Chrome + Red |  CL Chrome + Blue |  CV Chrome + Green |  C8C8 Polished Nickel |
|  C8W Polished Nickel+White |  C8N Polished Nickel+Black |  C8R Polished Nickel+Red |  C8L Polished Nickel+Blue |  C8V Polished Nickel+Green | | |

Brand ZUCCHETTI

Class

SAVOIR

SAVOIR

ZSV226.CN

Overall Drawing

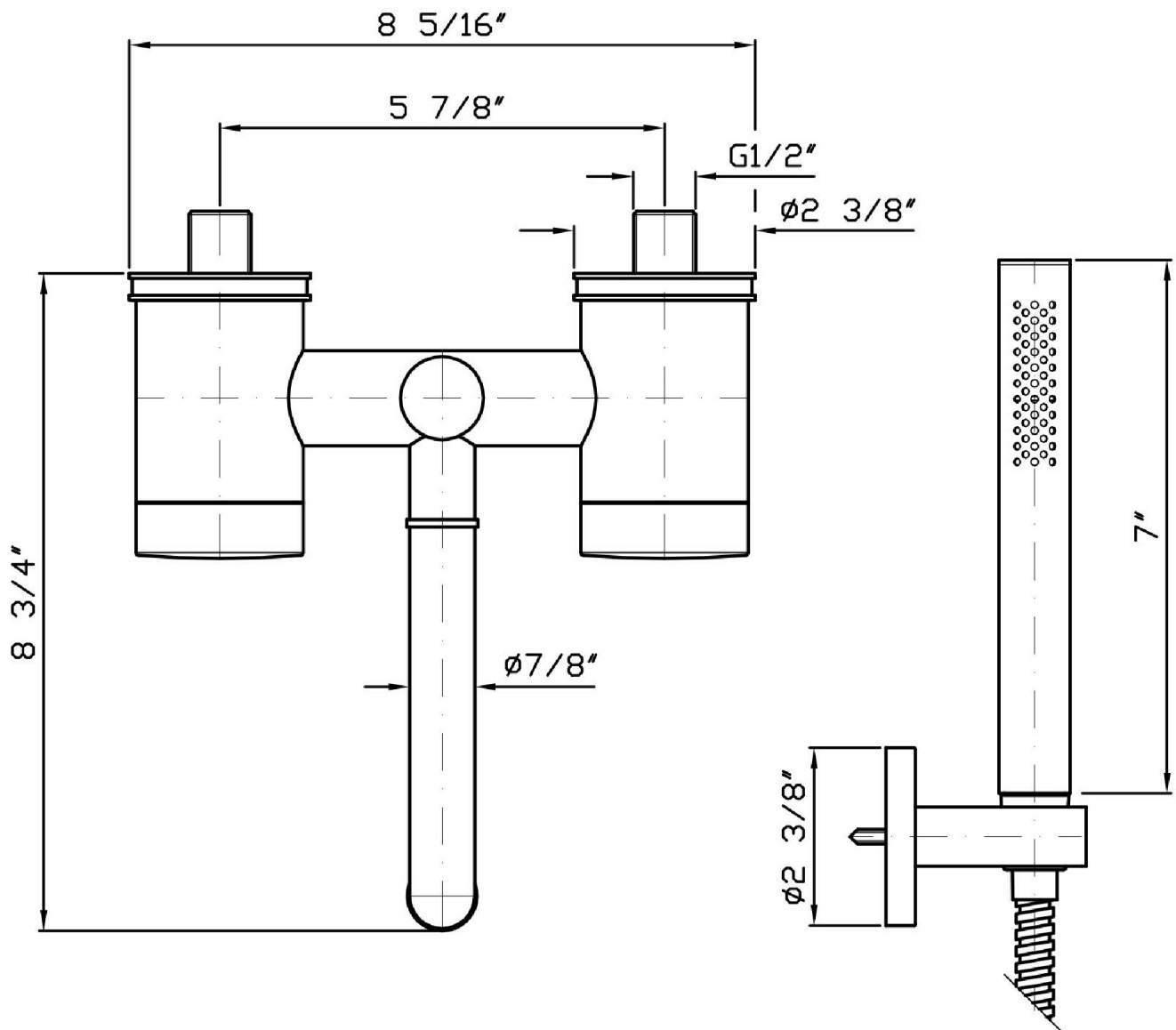

Brand ZUCCHETTI

Class

SAVOIR

SAVOIR

ZSV226.CN

Weights and Sizes

| | | |
|--------------------------|---------------|-------------------|
| Weight (lb) | 5,2 (Kg) | 11,46392 (lb) |
| Volume (dc3) - (in3) | 12,27 (dc3) | 0,000749 (in3) |
| h (mm) - (in) | 150 (mm) | 5,905515 (in) |
| L1 (mm) - (in) | 250 (mm) | 9,842525 (in) |
| L2 (mm) - (in) | 327 (mm) | 12,8740227 (in) |

