

Brand ZUCCHETTI

Class

SAVOIR

## SAVOIR

ZSV098.1900CN Built-in thermostatic shower mixer with 3 volume controls.















¾" built-in thermostatic shower mixer with 3 volume controls.  
7,6 GPM @ 43,5 PSI

R99632.1900

Rough-in



### Finishes

 CN	 CC	 CW	 CR	 CL	 CV	 C8C8
Chrome + Black	Chrome + Chrome	Chrome + White	Chrome + Red	Chrome + Blue	Chrome + Green	Polished Nickel
 C8W	 C8N	 C8R	 C8L	 C8V		
Polished Nickel+White	Polished Nickel+Black	Polished Nickel+Red	Polished Nickel+Blue	Polished Nickel+Green		

Brand ZUCCHETTI

Class

SAVOIR

## SAVOIR

### ZSV098.1900CN Overall Drawing

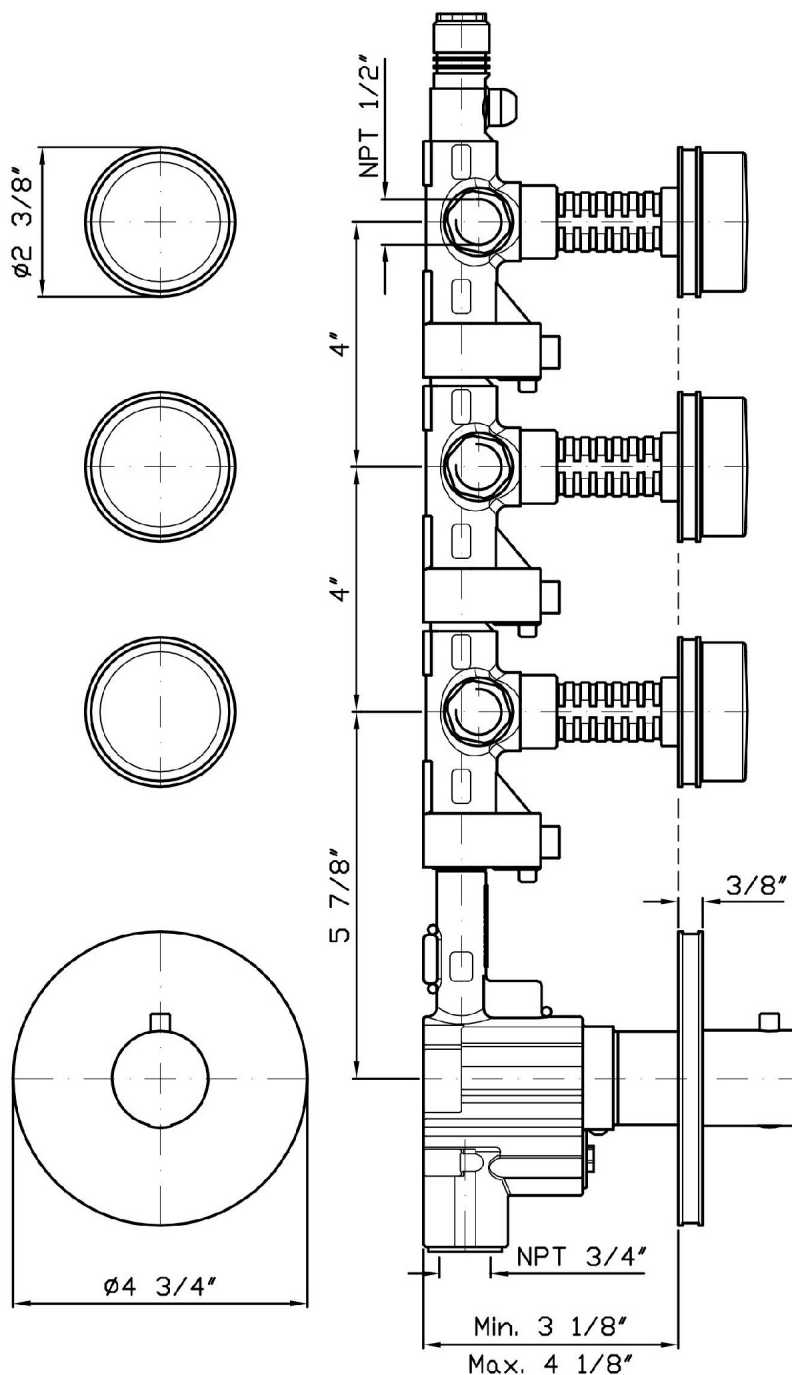

Brand ZUCCHETTI

Class

SAVOIR

## SAVOIR

### ZSV098.1900CN Certifications

USA

IAPMO

## SAVOIR

### ZSV098.1900CN Weights and Sizes

Weight ( lb )	3,09 ( Kg )	6,812214 ( lb )
Volume ( dc3 ) - ( in3 )	11,01 ( dc3 )	0,000672 ( in3 )
h ( mm ) - ( in )	90 ( mm )	3,543309 ( in )
L1 ( mm ) - ( in )	335 ( mm )	13,1889835 ( in )
L2 ( mm ) - ( in )	365 ( mm )	14,3700865 ( in )

