

Brand ZUCCHETTI

Class

SAVOIR

SAVOIR

ZSA729.1900CN Wall valve.















1/2" wall valve.

R99779.1900

Rough-in



Finishes

 CN	 CC	 CW	 GR	 CL	 CV	 C8C8
Chrome + Black	Chrome + Chrome	Chrome + White	Chrome + Red	Chrome + Blue	Chrome + Green	Polished Nickel
 C8W	 C8N	 C8R	 C8L	 C8V		
Polished Nickel+White	Polished Nickel+Black	Polished Nickel+Red	Polished Nickel+Blue	Polished Nickel+Green		

SAVOIR

ZSA729.1900CN Overall Drawing

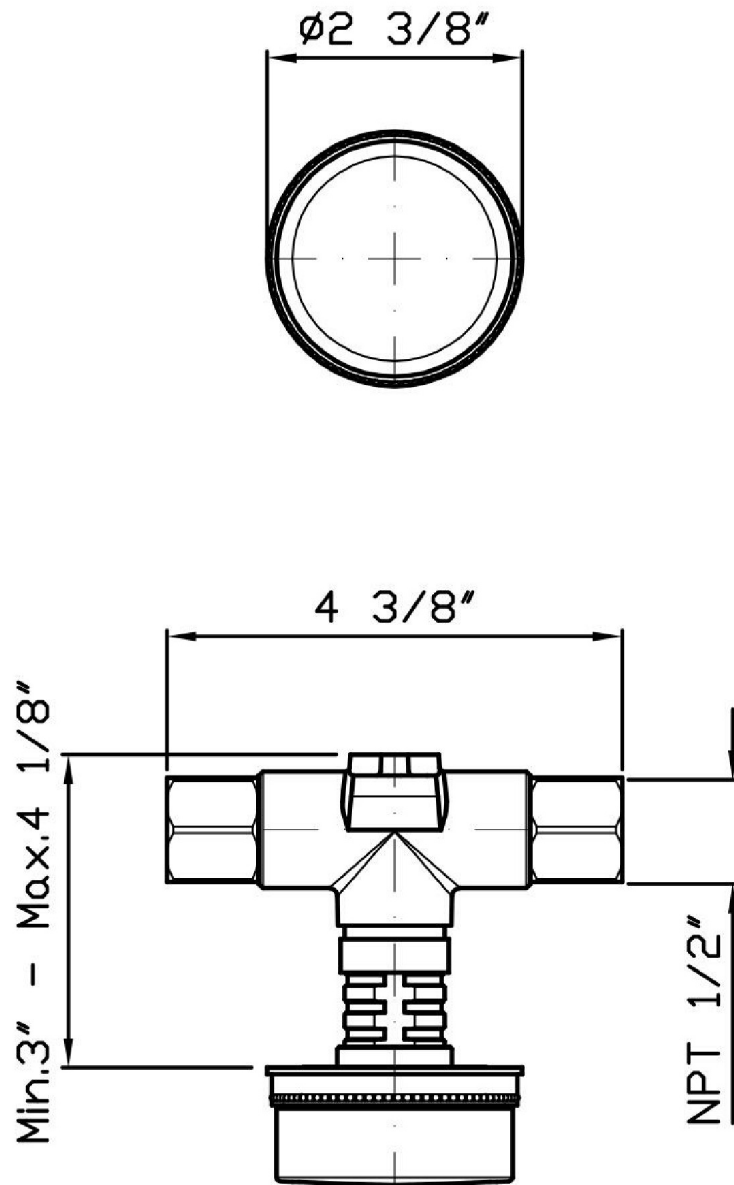

Brand ZUCCHETTI

Class

SAVOIR

SAVOIR

ZSA729.1900CN Exploded

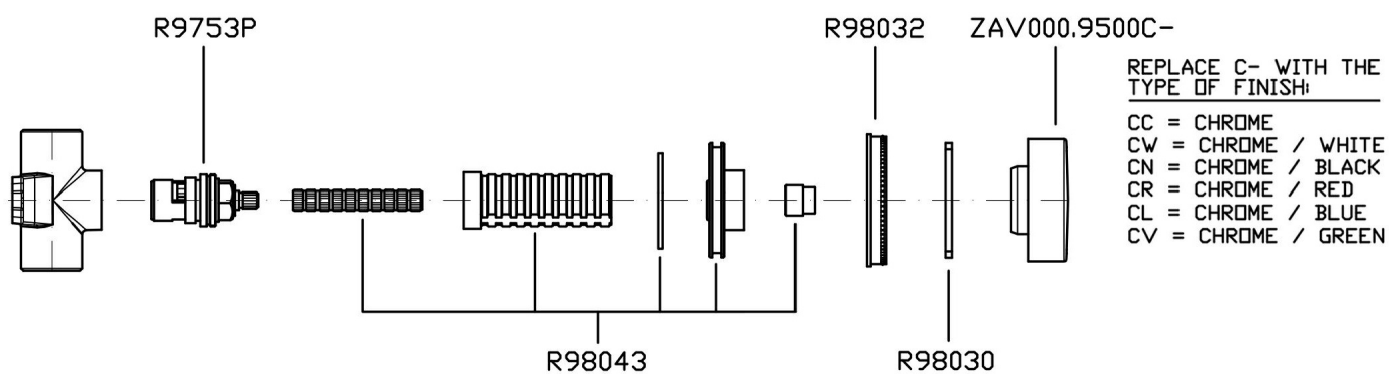

Brand ZUCCHETTI

Class

SAVOIR

SAVOIR

ZSA729.1900CN Certifications

USA

IAPMO

SAVOIR

ZSA729.1900CN Weights and Sizes

Weight (lb)	0,8 (Kg)	1,76368 (lb)
Volume (dc3) - (in3)	1,21 (dc3)	0,000074 (in3)
h (mm) - (in)	73 (mm)	2,8740173 (in)
L1 (mm) - (in)	127 (mm)	5,0000027 (in)
L2 (mm) - (in)	130 (mm)	5,118113 (in)

