

Brand ZUCCHETTI

Class

SAVOIR

SAVOIR

ZSA670.190ECN 3 hole built-in basin mixer.















3 hole built-in basin mixer, with aerator.
Spout projection 8 3/4".
Water flow restricted to 1 GPM.

R99500.190E

Assembled rough-in part, interaxe 8"



Finishes

 CN Chrome + Black	 CC Chrome + Chrome	 CW Chrome + White	 CR Chrome + Red	 CL Chrome + Blue	 CV Chrome + Green	 C8C8 Polished Nickel
 C8W Polished Nickel+White	 C8N Polished Nickel+Black	 C8R Polished Nickel+Red	 C8L Polished Nickel+Blue	 C8V Polished Nickel+Green		

Brand ZUCCHETTI

Class

SAVOIR

SAVOIR

ZSA670.190ECN Overall Drawing

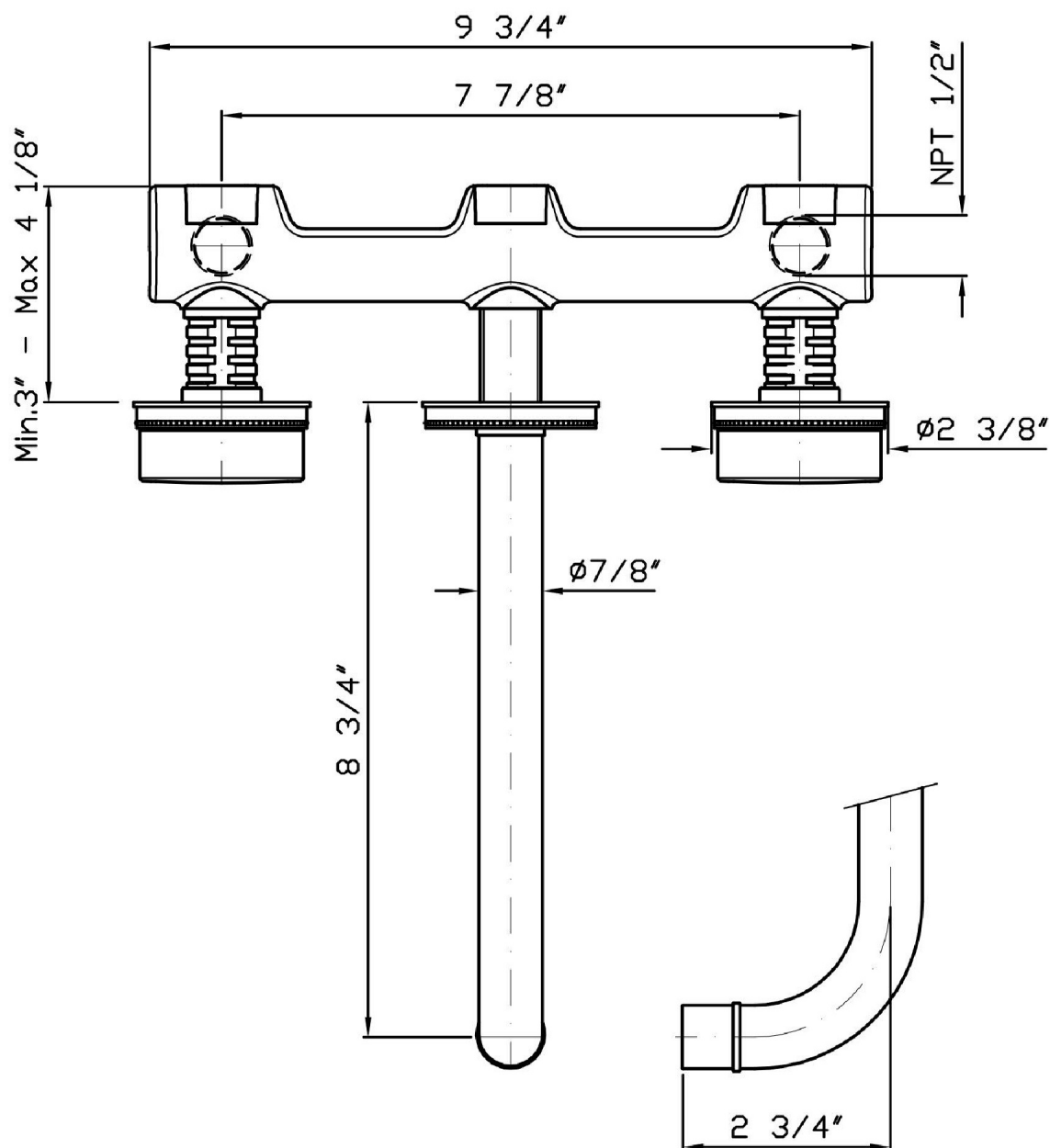

Brand ZUCCHETTI

Class

SAVOIR

SAVOIR

ZSA670.190ECN Exploded

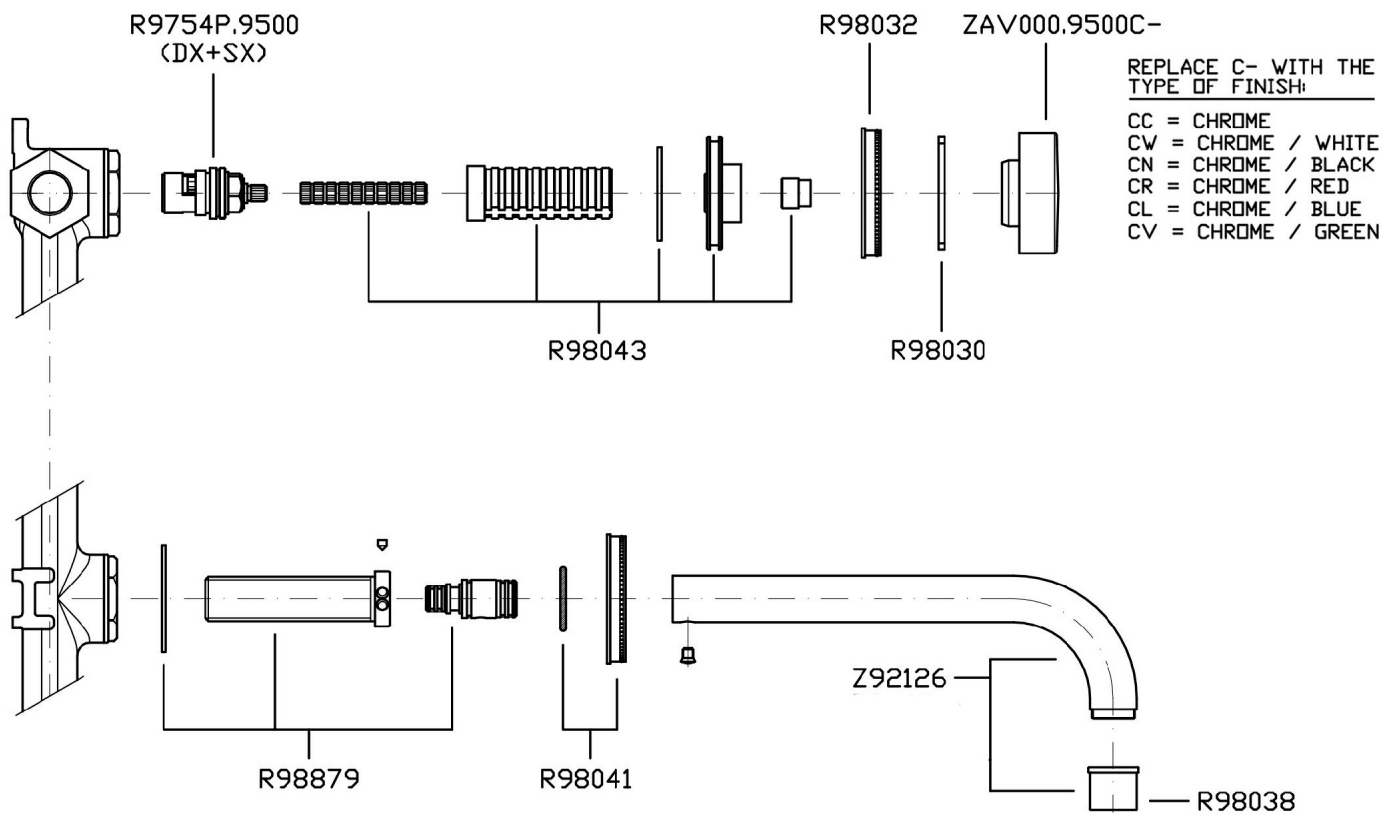

Brand ZUCCHETTI

Class

SAVOIR

SAVOIR

ZSA670.190ECN Certifications

USA

IAPMO

SAVOIR

ZSA670.190ECN Weights and Sizes

Weight (lb)	2,43 (Kg)	5,357178 (lb)
Volume (dc3) - (in3)	11,01 (dc3)	0,000672 (in3)
h (mm) - (in)	90 (mm)	3,543309 (in)
L1 (mm) - (in)	335 (mm)	13,1889835 (in)
L2 (mm) - (in)	365 (mm)	14,3700865 (in)

