













SAVOIR

ZSA402.195ECN 3 hole basin mixer.



3 hole basin mixer with aerator, pop-up waste, flexible hoses.
Spout projection 7 1/14".
Water flow restricted to 1 GPM.

Finiture / Finishes

 CN Chrome + Black	 CC Chrome + Chrome	 CW Chrome + White	 CR Chrome + Red	 CL Chrome + Blue	 CV Chrome + Green	 C8C8 Polished Nickel
 C8W Polished Nickel+White	 C8N Polished Nickel+Black	 C8R Polished Nickel+Red	 C8L Polished Nickel+Blue	 C8V Polished Nickel+Green		

SAVOIR

ZSA402.195ECN Disegno Complessivo / Overall Drawing

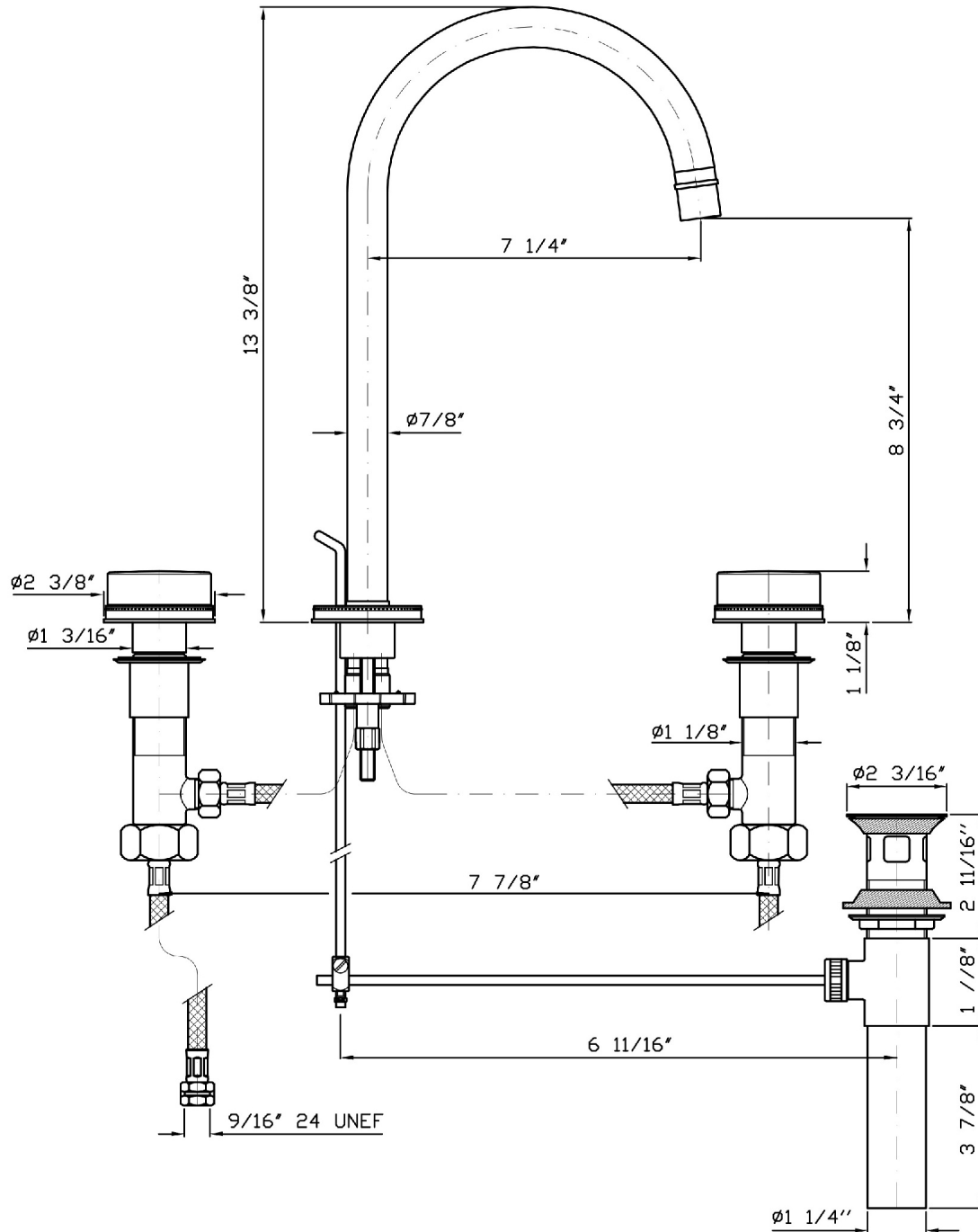

SAVOIR

ZSA402.195ECN Esplosi / Exploded

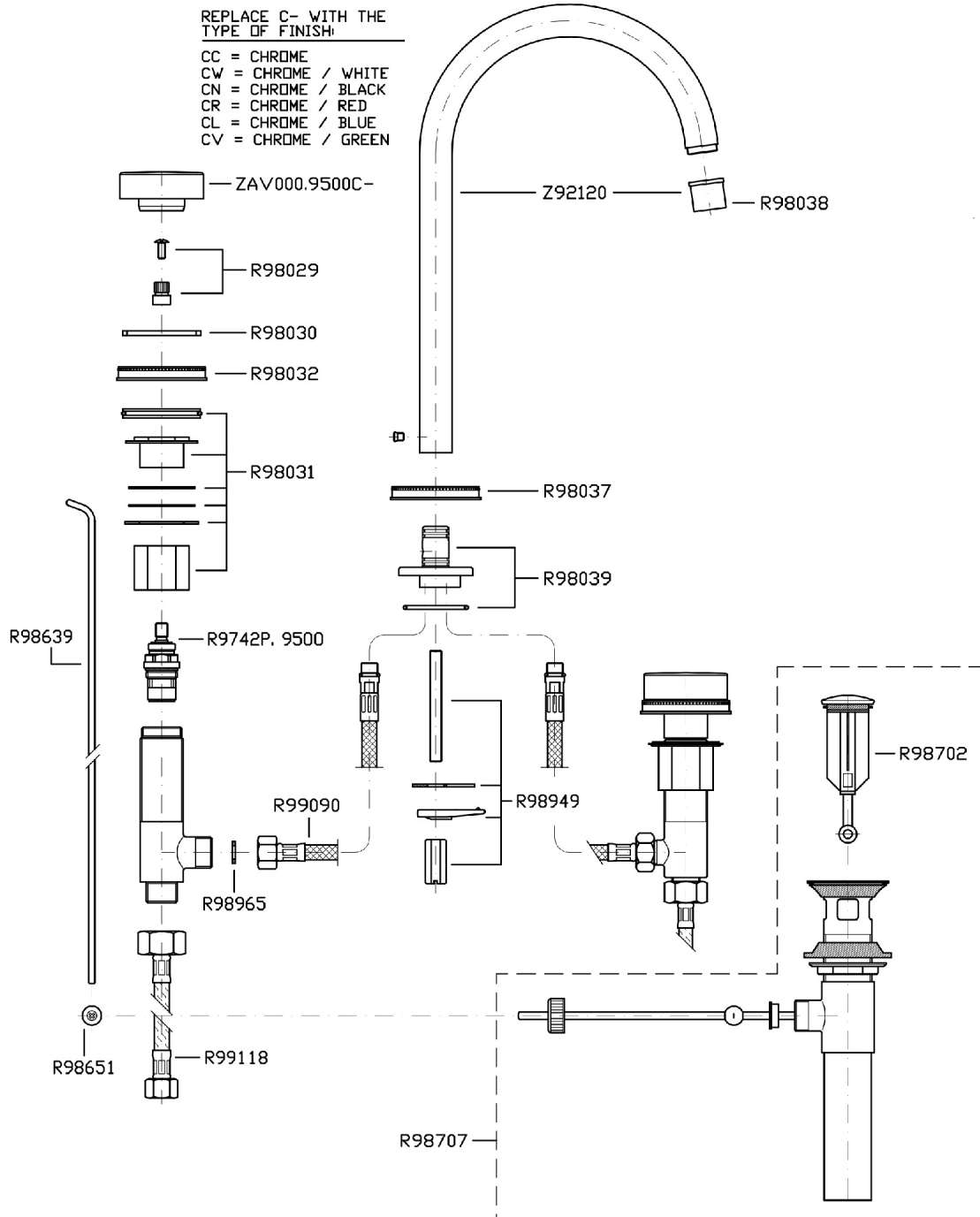

SAVOIR

ZSA402.195ECN Pesi e Misure / Weights and Sizes

Peso (Kg) Weight (lb)	3,88 (Kg)	8,553848 (lb)
Volume (dc3) - (in3)	15,98 (dc3)	0,000975 (in3)
h (mm) - (in)	90 (mm)	3,543309 (in)
L1 (mm) - (in)	335 (mm)	13,1889835 (in)
L2 (mm) - (in)	530 (mm)	20,866153 (in)

