

Brand ZUCCHETTI

Class

SAVOIR

SAVOIR













ZSA226.CN

Exposed bath-shower mixer.



Exposed bath-shower mixer with antispash, diverter, handshower, flexible hose 59".
Spout projection 8 3/4".

Finishes

 CN Chrome + Black	 CC Chrome + Chrome	 CW Chrome + White	 CR Chrome + Red	 CL Chrome + Blue	 CV Chrome + Green	 C8C8 Polished Nickel
 C8W Polished Nickel+White	 C8N Polished Nickel+Black	 C8R Polished Nickel+Red	 C8L Polished Nickel+Blue	 C8V Polished Nickel+Green		

Brand ZUCCHETTI

Class

SAVOIR

SAVOIR

ZSA226.CN

Overall Drawing

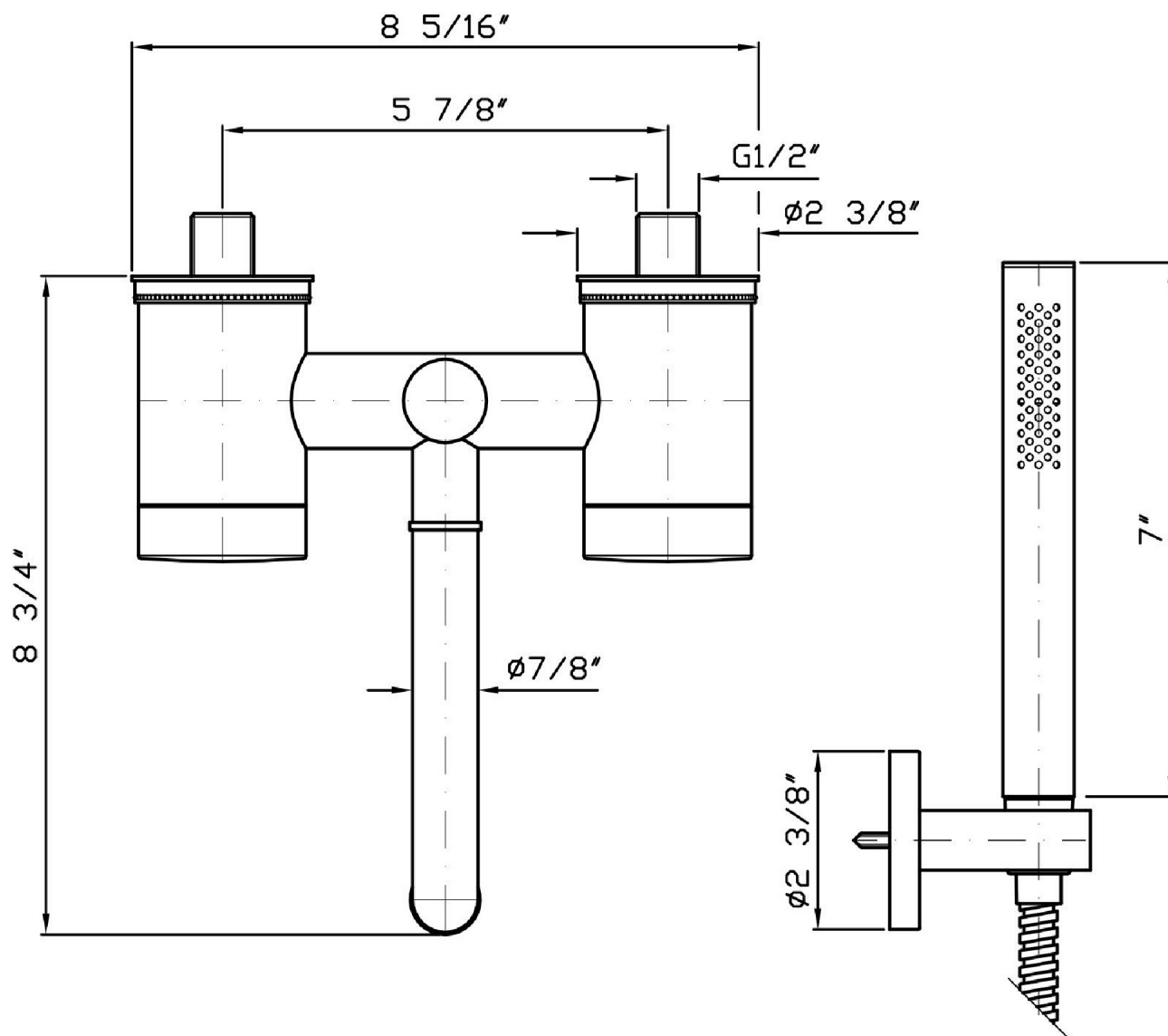

Brand ZUCCHETTI

Class

SAVOIR

SAVOIR

ZSA226.CN

Weights and Sizes

Weight (lb)	5,2 (Kg)	11,46392 (lb)
Volume (dc3) - (in3)	12,27 (dc3)	0,000749 (in3)
h (mm) - (in)	150 (mm)	5,905515 (in)
L1 (mm) - (in)	250 (mm)	9,842525 (in)
L2 (mm) - (in)	327 (mm)	12,8740227 (in)

