

Marchio / Brand ZUCCHETTI

PAN

PAN

ZP8729.1900 Wall valve.













½" wall valve.

R99779.1900

Rough-in



Finiture / Finishes

	 C3	 C8	 C40	 C41	 C50	 C51
Chrome	Brushed Nickel	Polished Nickel	Gold	Brushed Gold	Metal Black	Brushed Metal Black
 W1	 N1	 N7				
Embossed Matt White	Embossed Matt Black	Soft Touch Black				

PAN

ZP8729.1900 Disegno Complessivo / Overall Drawing

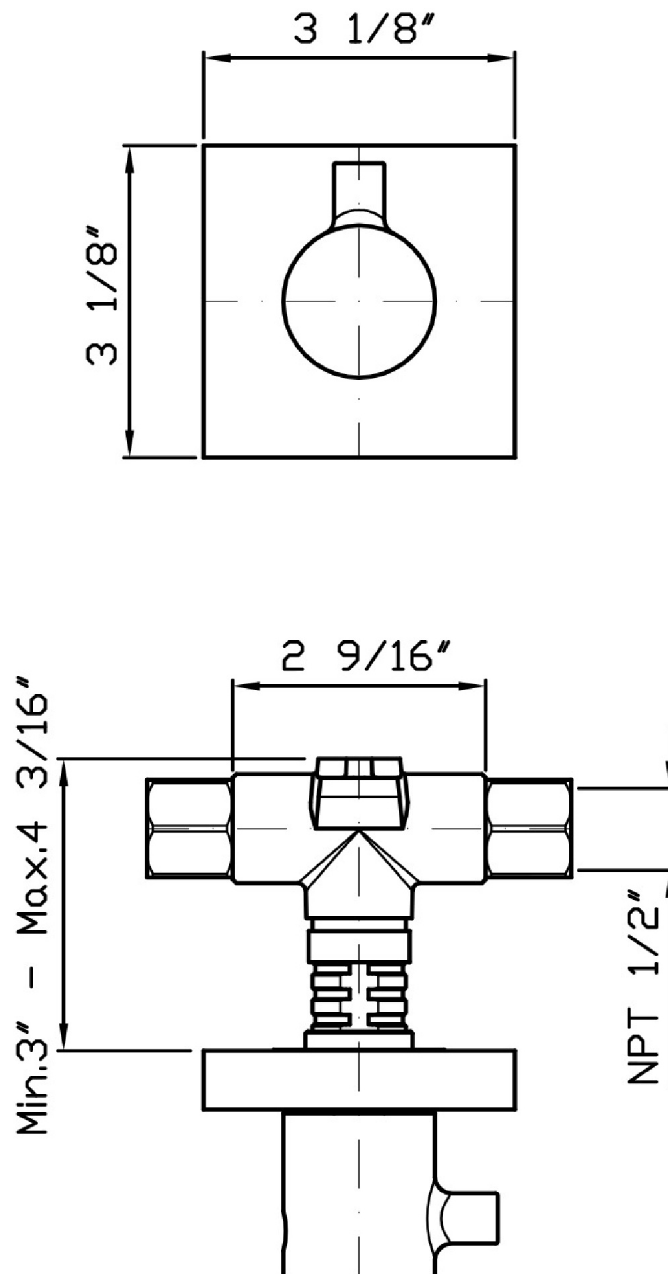

PAN

ZP8729.1900 Esplosi / Exploded

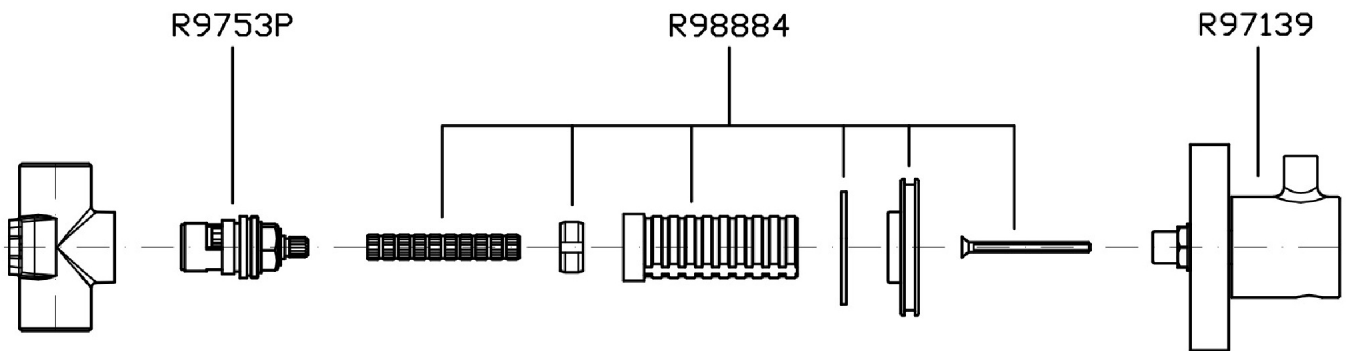

Marchio / Brand ZUCCHETTI

PAN

PAN

ZP8729.1900 Certificazioni / Certifications

USA

IAPMO

PAN

ZP8729.1900 Pesì e Misure / Weights and Sizes

Peso (Kg) Weight (lb)	1,11 (Kg)	2,45 (lb)
Volume test (dc3) - (in3)	3,32 (dc3)	202,60 (in3)
h (mm) - (in)	93,00 (mm)	3,66 (in)
L1 (mm) - (in)	162,00 (mm)	6,38 (in)
L2 (mm) - (in)	220,00 (mm)	8,66 (in)

