

PAN

ZP6318.190E 2 hole built-in single lever basin mixer.













2 hole built-in single lever basin mixer with aerator. Spout projection 9 1/16". Water flow restricted to 1,2 GPM.

R99815.190E

Rough-in



Finiture / Finishes

	 C3	 C8	 C40	 C41	 C50	 C51
Chrome	Brushed Nickel	Polished Nickel	Gold	Brushed Gold	Metal Black	Brushed Metal Black
 W1	 N1	 N7				
Embossed Matt White	Embossed Matt Black	Soft Touch Black				

PAN

ZP6318.190E Disegno Complessivo / Overall Drawing

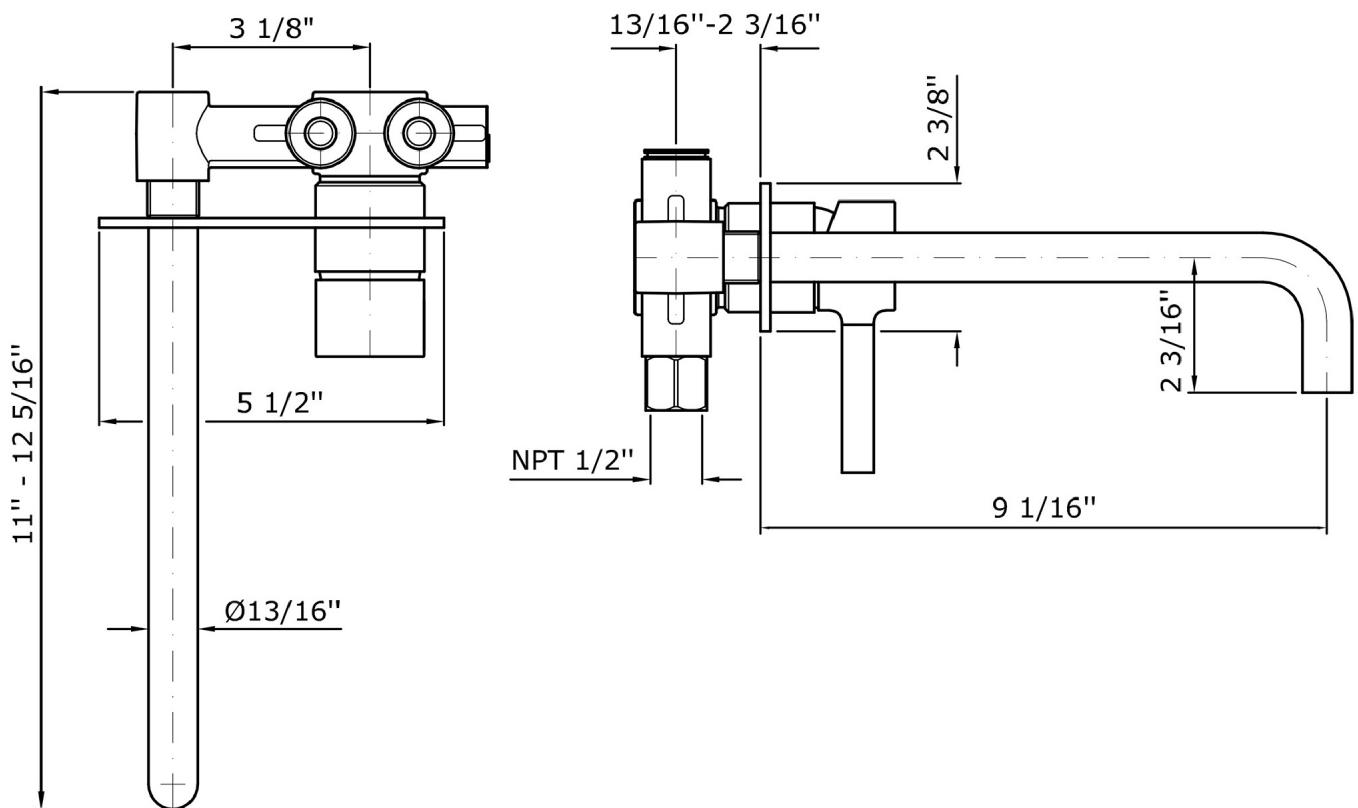

PAN

ZP6318.190E Esplosi / Exploded

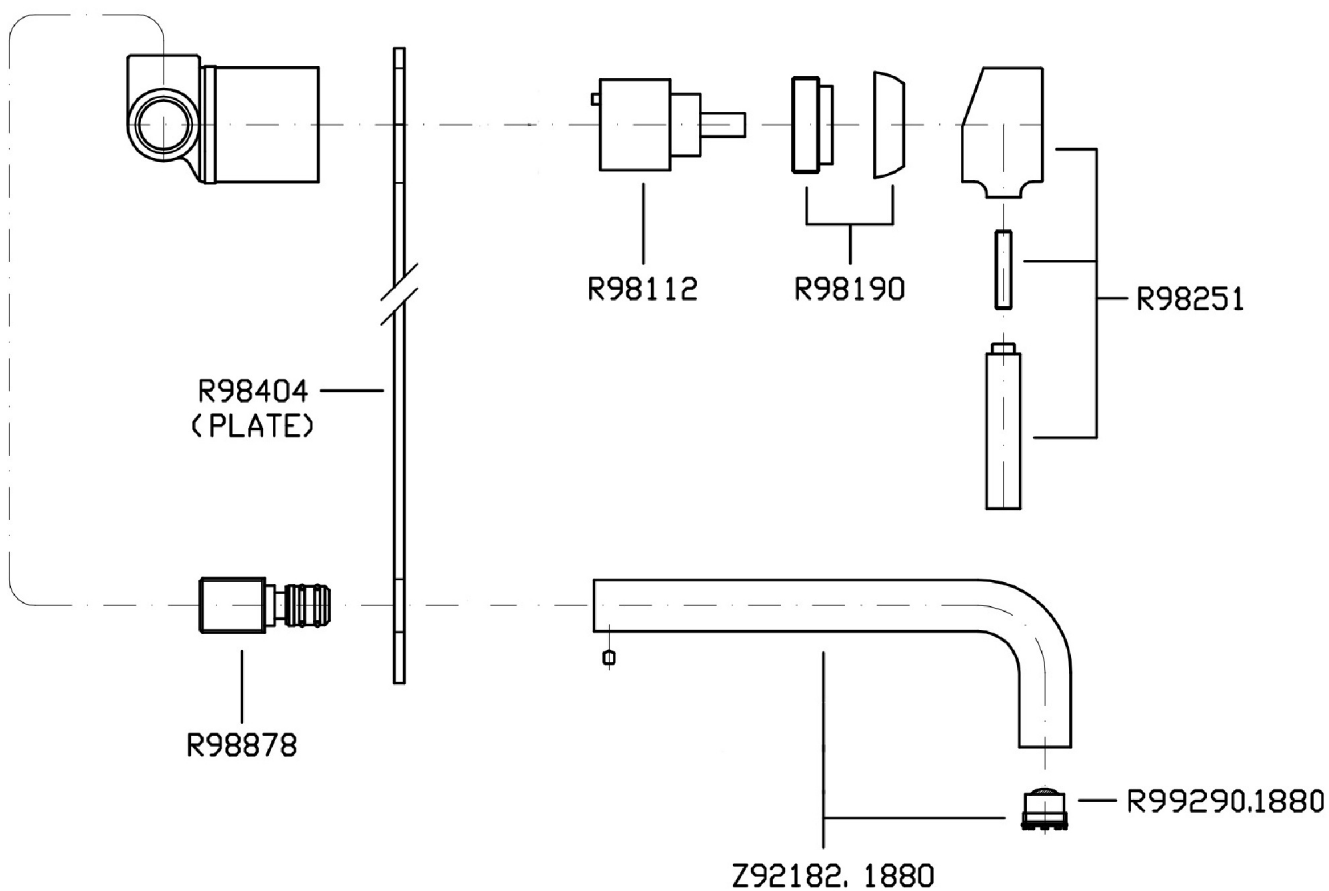

Marchio / Brand ZUCCHETTI

PAN

PAN

ZP6318.190E Certificazioni / Certifications

USA

IAPMO

PAN

ZP6318.190E Pesì e Misure / Weights and Sizes

Peso (Kg) Weight (lb)	0,97 (Kg)	2,14 (lb)
Volume test (dc3) - (in3)	3,32 (dc3)	202,60 (in3)
h (mm) - (in)	93,00 (mm)	3,66 (in)
L1 (mm) - (in)	162,00 (mm)	6,38 (in)
L2 (mm) - (in)	220,00 (mm)	8,66 (in)

