

Marchio / Brand ZUCCHETTI

JINGLE

JINGLE









ZIN693.195E

Single lever basin mixer.



Single lever basin mixer with aerator, without pop-up waste, flexible hoses. Spout projection 4 3/4". Water flow restricted to 1 GPM.

Finiture / Finishes

		C3		C8		C40		C41		C50		C51
Chrome	Brushed Nickel		Polished Nickel		Gold		Brushed Gold		Metal Black		Brushed Metal Black	
	W1		N1									
Embossed Matt White		Embossed Matt Black										

JINGLE

ZIN693.195E Disegno Complessivo / Overall Drawing

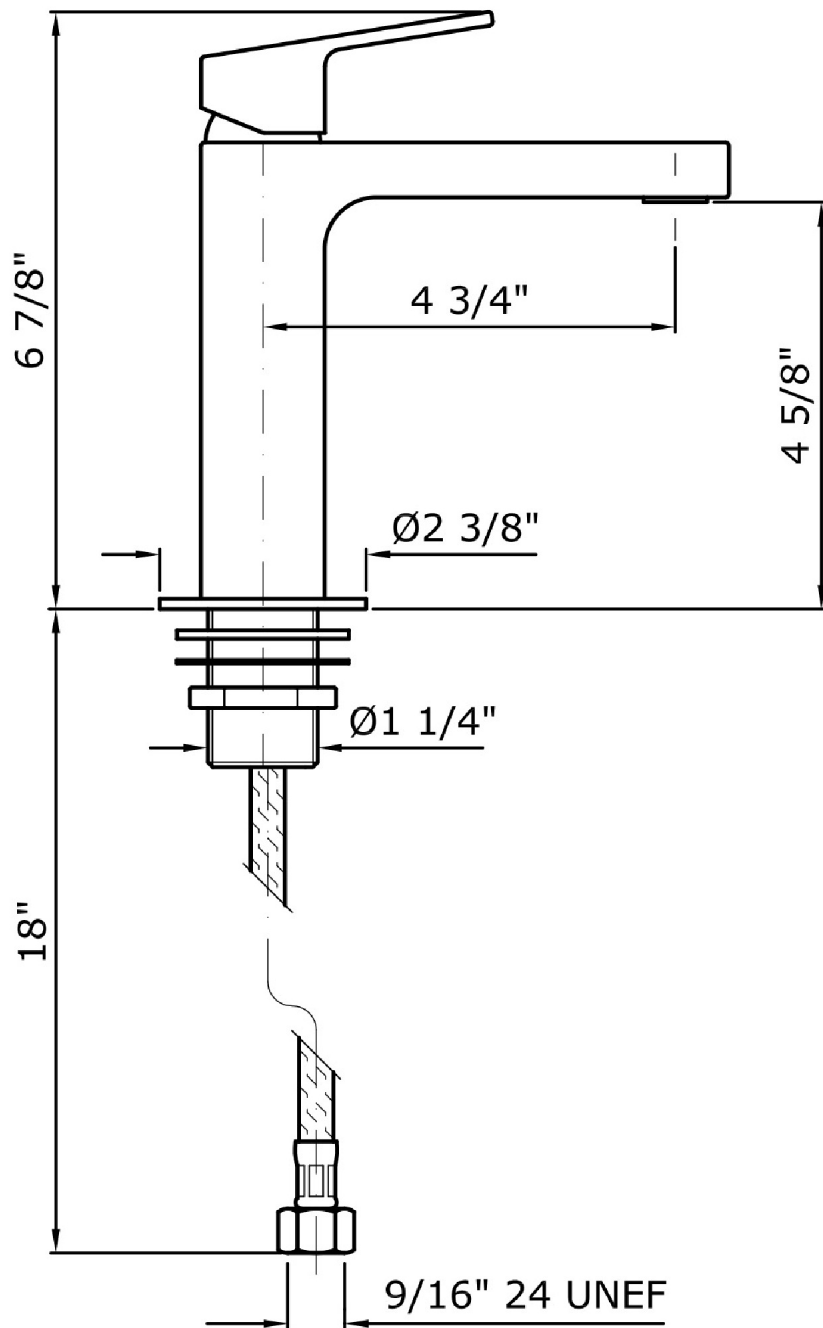

JINGLE

ZIN693.195E Esplosi / Exploded

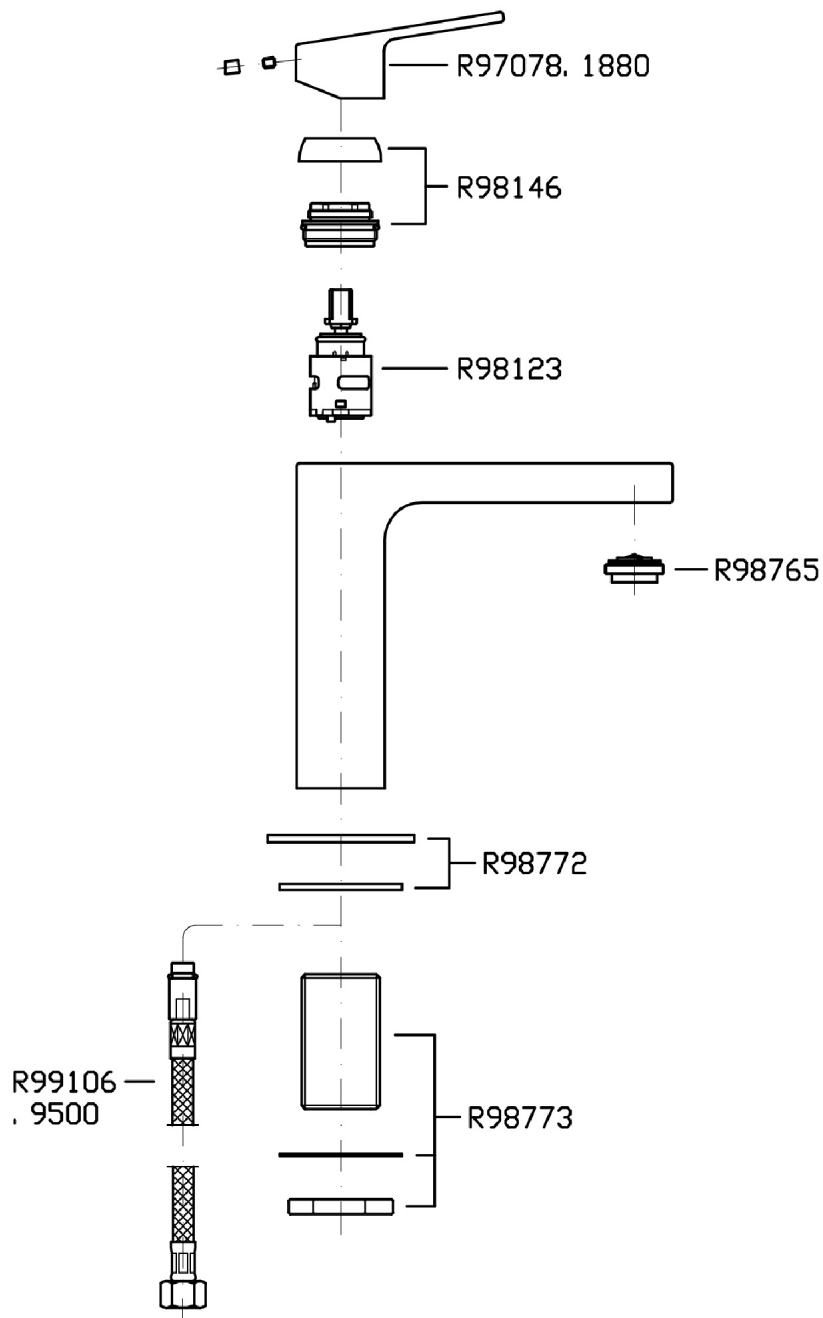

Marchio / Brand ZUCCHETTI

JINGLE

JINGLE

ZIN693.195E Certificazioni / Certifications

USA

IAPMO

JINGLE

ZIN693.195E Pesì e Misure / Weights and Sizes

Peso (Kg) Weight (lb)	1,63 (Kg)	3,60 (lb)
Volume test (dc3) - (in3)	4,05 (dc3)	247,15 (in3)
h (mm) - (in)	70,00 (mm)	2,76 (in)
L1 (mm) - (in)	150,00 (mm)	5,91 (in)
L2 (mm) - (in)	385,00 (mm)	15,16 (in)

