

## JINGLE









ZIN311.195E

Single lever bidet mixer with aerator, pop-up waste, flexible hoses.



Single lever bidet mixer with aerator, pop-up waste, flexible hoses.

### Finiture / Finishes

		C3		C8		C40		C41		C50		C51
Chrome	Brushed Nickel		Polished Nickel		Gold		Brushed Gold		Metal Black		Brushed Metal Black	
	W1		N1									
Embossed Matt White		Embossed Matt Black										

## JINGLE

ZIN311.195E Disegno Complessivo / Overall Drawing

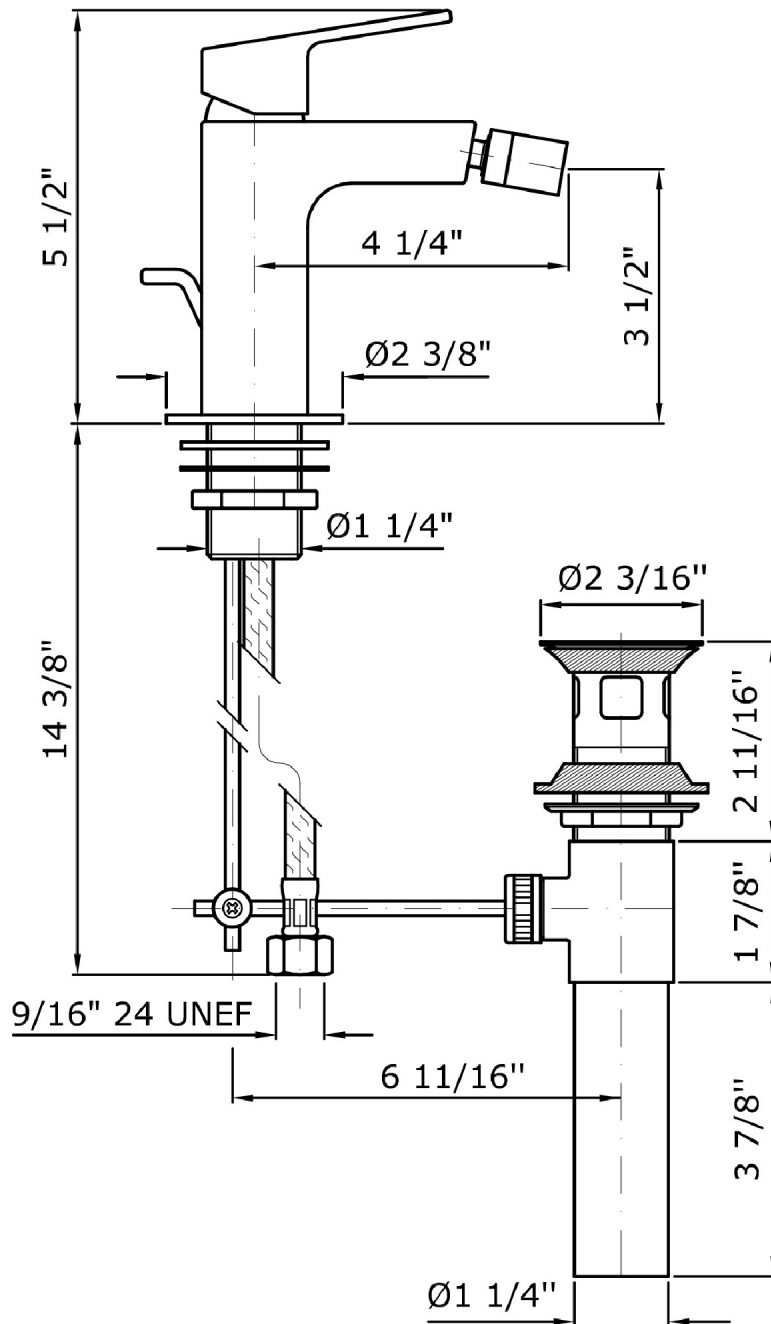

## JINGLE

ZIN311.195E      Esplosi / Exploded

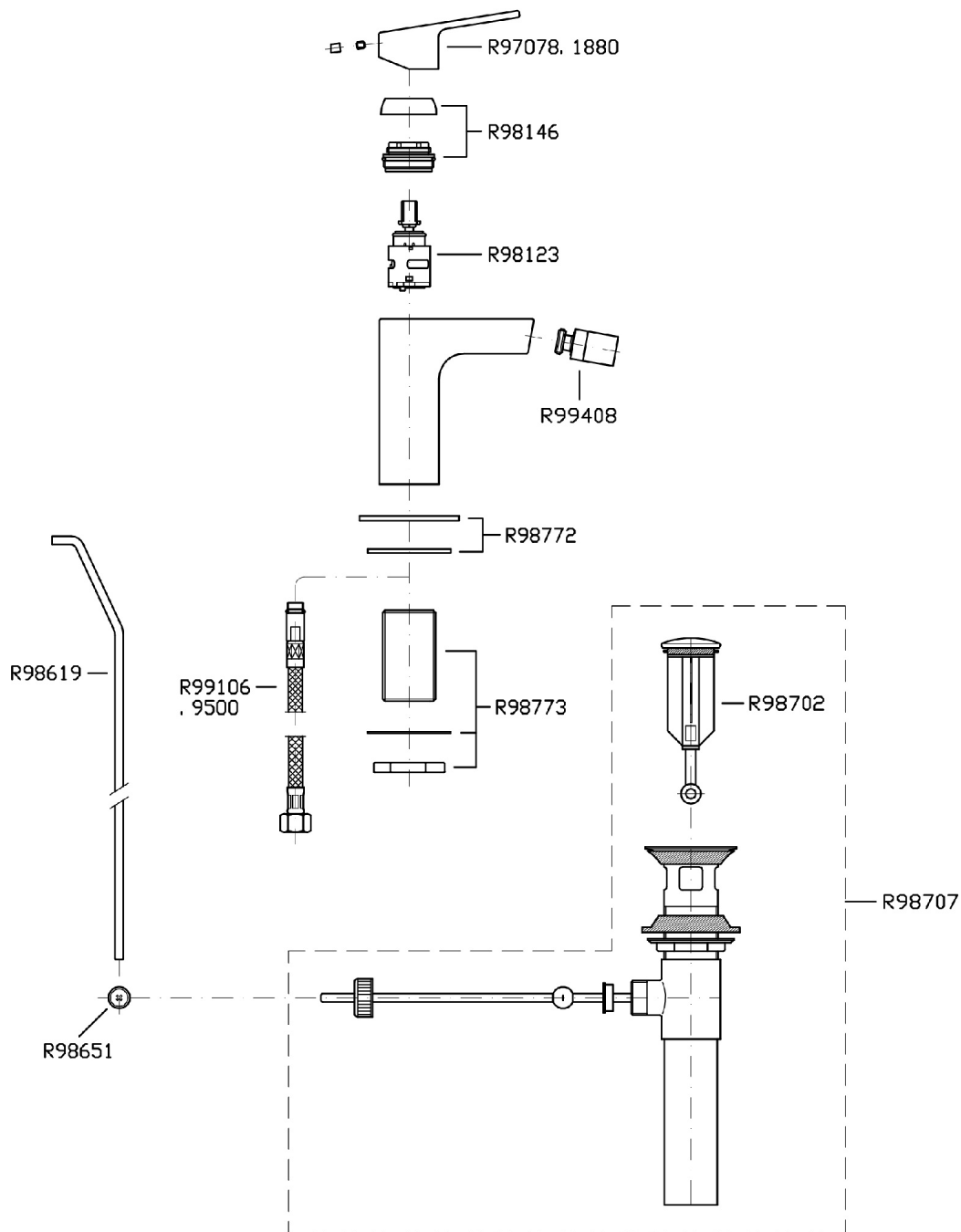

## JINGLE

ZIN311.195E

Certificazioni / Certifications

USA

IAPMO

## JINGLE

ZIN311.195E

Pesi e Misure / Weights and Sizes

Peso ( Kg ) Weight ( lb )	1,82 ( Kg )	4,01 ( lb )
Volume test ( dc3 ) - ( in3 )	4,05 ( dc3 )	247,15 ( in3 )
h ( mm ) - ( in )	70,00 ( mm )	2,76 ( in )
L1 ( mm ) - ( in )	150,00 ( mm )	5,91 ( in )
L2 ( mm ) - ( in )	385,00 ( mm )	15,16 ( in )

