

Marchio / Brand ZUCCHETTI

ACCESSORIES

PAN











ZAC651

Double hook.



Double hook.

Finiture / Finishes

	 C3	 C8	 C40	 C41	 C50	 C51
Chrome	Brushed Nickel	Polished Nickel	Gold	Brushed Gold	Metal Black	Brushed Metal Black
 W1	 N1	 N7				
Embossed Matt White	Embossed Matt Black	Soft Touch Black				

PAN

ZAC651

Disegno Complessivo / Overall Drawing

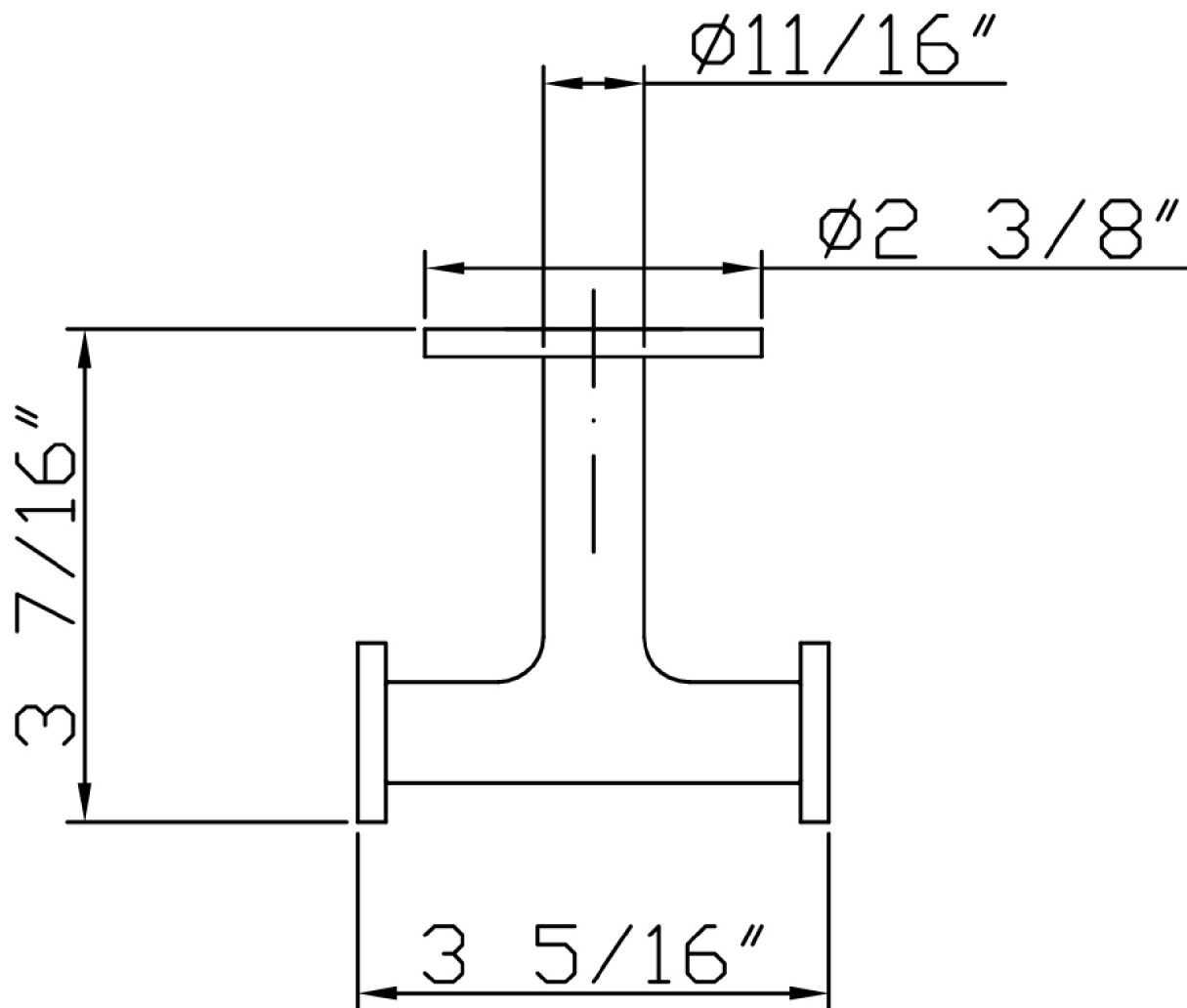

PAN

ZAC651**Pesi e Misure / Weights and Sizes**

Peso (Kg) Weight (lb)	0,57 (Kg)	1,26 (lb)
Volume test (dc3) - (in3)	1,21 (dc3)	73,84 (in3)
h (mm) - (in)	73,00 (mm)	2,87 (in)
L1 (mm) - (in)	127,00 (mm)	5,00 (in)
L2 (mm) - (in)	130,00 (mm)	5,12 (in)

