

## MISCELLANEOUS

Z94651.1900 Built-in thermostatic shower mixer with stop valve.













1/2" built-in thermostatic shower mixer with integrated stop valve and 2 way diverter. 4,86 GPM @ 43,5 PSI

R98662.1900

Rough-in



### Finiture / Finishes

	 C3	 C8	 C40	 C41	 C50	 C51
Chrome	Brushed Nickel	Polished Nickel	Gold	Brushed Gold	Metal Black	Brushed Metal Black
 W1	 N1	 N7				
Embossed Matt White	Embossed Matt Black	Soft Touch Black				

## MISCELLANEOUS

Z94651.1900 Disegno Complessivo / Overall Drawing

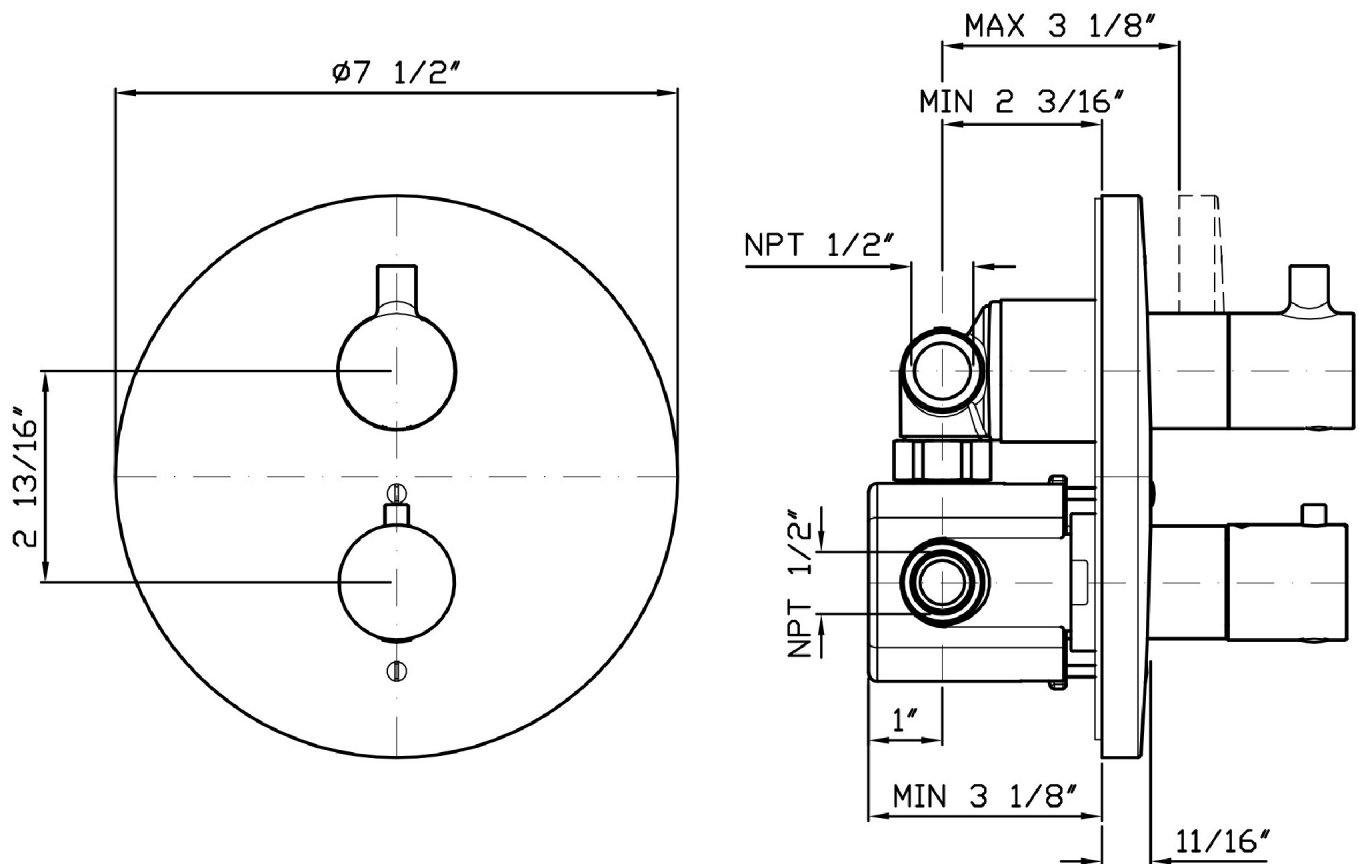

## MISCELLANEOUS

Z94651.1900 Certificazioni / Certifications

USA

IAPMO

## MISCELLANEOUS

Z94651.1900 Pesì e Misure / Weights and Sizes

Peso ( Kg ) Weight ( lb )	1,09 ( Kg )	2,40 ( lb )
Volume test ( dc3 ) - ( in3 )	3,32 ( dc3 )	202,60 ( in3 )
h ( mm ) - ( in )	93,00 ( mm )	3,66 ( in )
L1 ( mm ) - ( in )	162,00 ( mm )	6,38 ( in )
L2 ( mm ) - ( in )	220,00 ( mm )	8,66 ( in )

