

## PAN

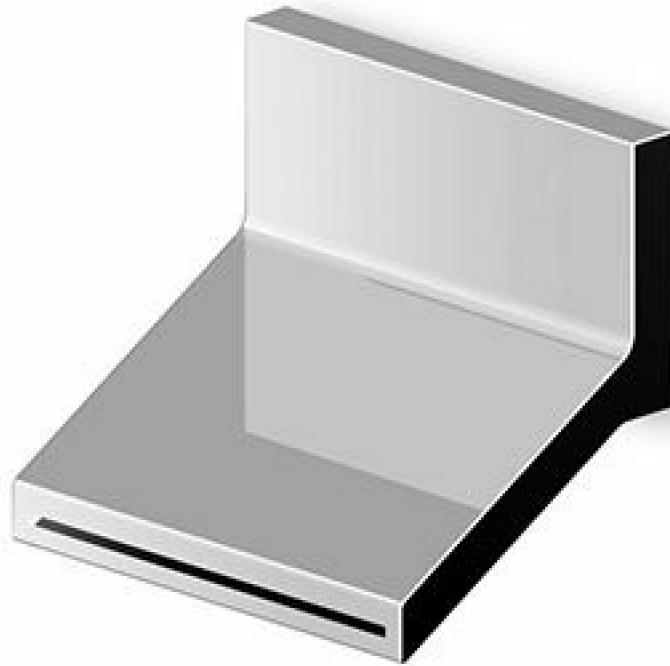









Z93730.1900

Blade flow spout.



Blade flow spout. Spout projection 4 3/16". Flowrate 1,5 GPM.

### Finiture / Finishes

	 C3	 C8	 C40	 C41	 C50	 C51
Chrome	Brushed Nickel	Polished Nickel	Gold	Brushed Gold	Metal Black	Brushed Metal Black
 W1	 N1	 N7				
Embossed Matt White	Embossed Matt Black	Soft Touch Black				

## PAN

Z93730.1900 Disegno Complessivo / Overall Drawing

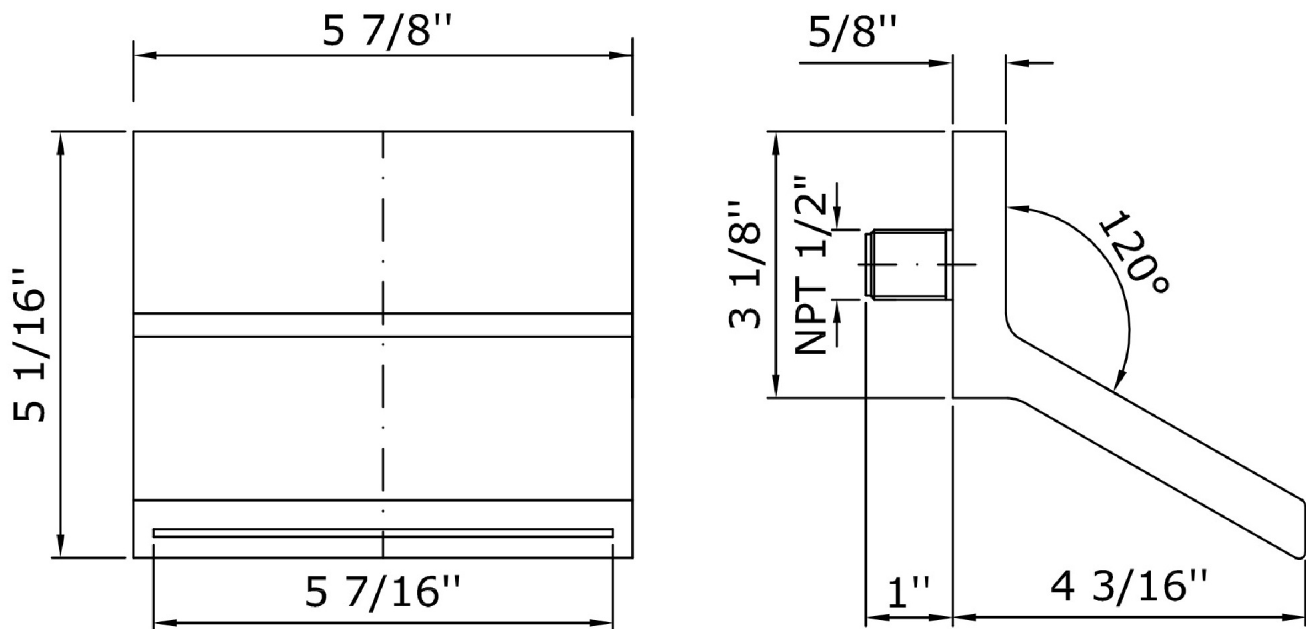

## PAN

Z93730.1900 Certificazioni / Certifications

USA

IAPMO

## PAN

Z93730.1900 Pesì e Misure / Weights and Sizes

Peso ( Kg ) Weight ( lb )	1,05 ( Kg )	2,31 ( lb )
Volume test ( dc3 ) - ( in3 )	4,42 ( dc3 )	269,72 ( in3 )
h ( mm ) - ( in )	120,00 ( mm )	4,72 ( in )
L1 ( mm ) - ( in )	160,00 ( mm )	6,30 ( in )
L2 ( mm ) - ( in )	230,00 ( mm )	9,06 ( in )

