



# Model 375

## Reduced Pressure Principle Assembly

### Application

Designed for installation on irrigation water lines to protect against both backsiphonage and backpressure of contaminated water into the potable water supply. Assembly shall provide protection where a potential health hazard exists. For non-potable applications only.

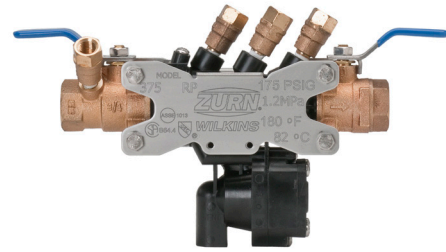

### Standards Compliance

- ASSE® Listed 1013
- IAPMO® Listed
- CSA® B64.4
- AWWA compliant C511
- Approved by the Foundation for Cross Connection Control and Hydraulic Research at the University of Southern California

### Materials

Housing	Reinforced Nylon
Fasteners	Stainless Steel, 300 Series
Elastomers	Silicone
	Buna Nitrile
Internals	Delrin, Nylon
Springs	Stainless steel, 300 series
Ball Valves	Cast Bronze, ASTM B 584
Struts	Stainless Steel, 300 Series

### Features

Sizes: 1/2", 3/4", 1", 1-1/4", 1-1/2", 2"	
Maximum working water pressure	175 PSI
Maximum working water temperature	180°F
Hydrostatic test pressure	350 PSI
End connections Threaded FNPT	ANSI B1.20.1

### Options

- (Suffixes can be combined)
- with full port QT ball valves (standard)
  - S - with bronze "Y" type strainer
  - SE - with street elbows
  - FT - with integral male 45° flare SAE test fitting
  - AG - with air gap
  - SAG - with bronze "Y" strainer and air gap

### Accessories

- Repair kits
- Thermal expansion tank (Mdl. XT)
- Soft seated check valve (Mdl. 40XL2)
- Shock arrester (Model 1260XL)
- QT-SET Quick Test Fitting Set
- Blow out / Flush fitting (RK34-375BOF (1/2" or 3/4"), RK1-375BOF or RK114-350-375BOF)

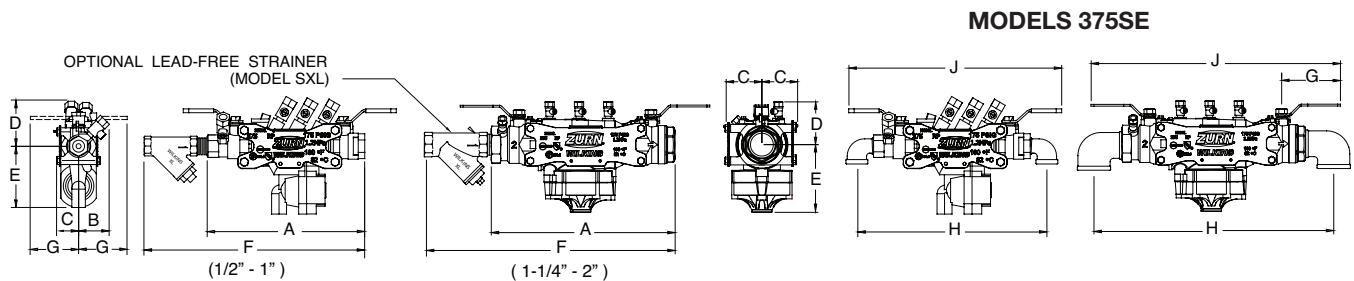

### Dimensions & Weights (do not include pkg.)

MODEL 375 SIZE	DIMENSIONS (approximate)																				WEIGHT				
	A		A LESS BALL VALVES		B		C		D		E		F		G		H		J		LESS BALL VALVES		WITH BALL VALVES		
	in.	mm	in.	mm	in.	mm	in.	mm	in.	mm	in.	mm	in.	mm	in.	mm	in.	mm	in.	mm	lbs.	kg	lbs.	kg	
1/2	20	8 7/8	225	n/a	n/a	1 15/16	49	1 3/8	35	2 15/16	75	3 7/8	98	12 1/4	311	3	76	10 7/8	276	12 1/4	311	4.7	2.1	5.7	2.6
3/4	20	8 7/8	225	7 1/8	181	1 15/16	49	1 3/8	35	2 15/16	75	3 7/8	98	12 5/8	321	3	76	11	279	12 1/4	311	4.7	2.1	5.7	2.6
1	25	11 3/16	284	8 7/8	225	2 1/4	57	1 13/16	46	3 7/16	87	4	102	14 9/16	370	4	102	13 3/4	349	15 1/4	387	8.2	3.7	9.7	4.4
1-1/4	32	14 7/8	378	14 3/8	367	3 3/8	86	3 1/8	80	3 3/4	95	5 3/4	146	20 1/2	521	3 3/4	95	18	457	18 1/2	470	18.7	8.5	20.5	9.3
1-1/2	40	15 1/4	387	14 3/8	367	3 3/8	86	3 1/8	80	3 3/4	95	5 3/4	146	22	559	4 1/2	114	18 3/4	476	20 1/4	514	18.3	8.0	21.5	9.8
2	50	16	406	14 3/8	367	3 3/8	86	3 1/8	80	3 3/4	95	5 3/4	146	24	610	4 3/4	120.7	20 3/4	527	20 3/4	527	19.4	8.8	23.5	10.7

**MODEL 375 1/2", 3/4" & 1" (STANDARD & METRIC)**

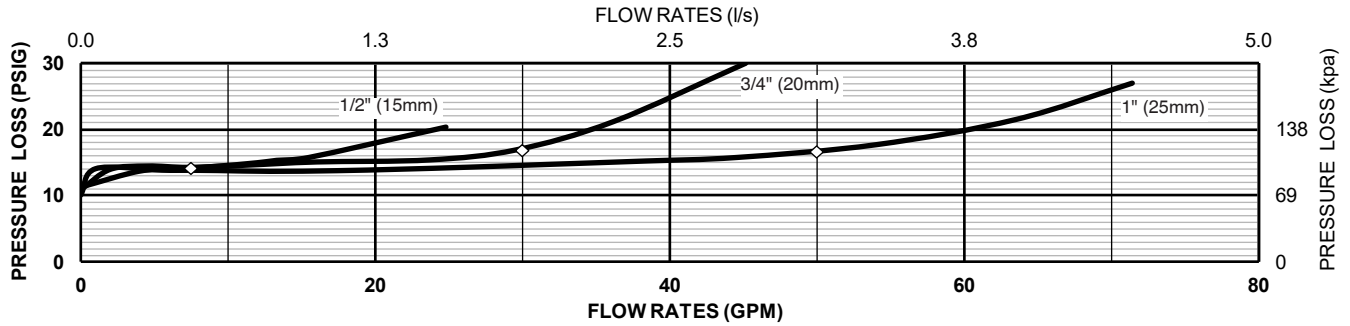

**MODEL 375 1-1/4", 1-1/2" & 2" (STANDARD & METRIC)**

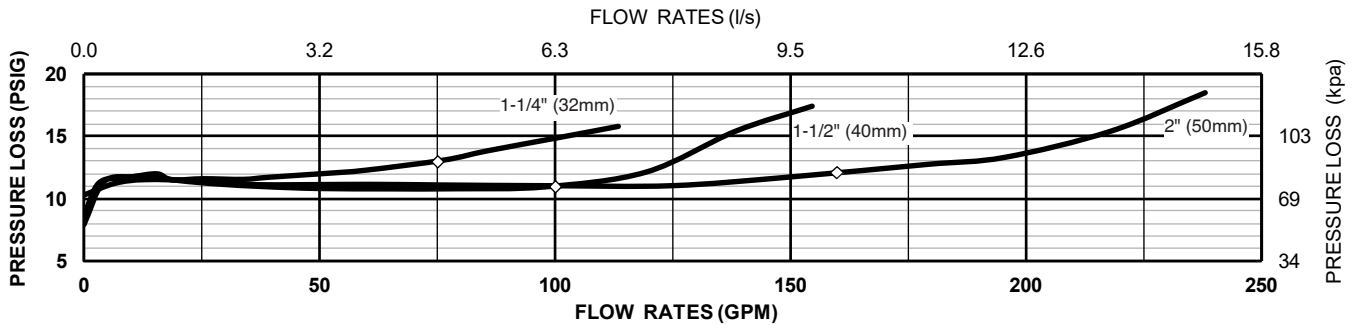

**Typical Installation**

Local codes shall govern installation requirements. To be installed in accordance with the manufacturers' instructions and the latest edition of the Uniform Plumbing Code. Unless otherwise specified, the assembly shall be mounted at a minimum of 12" (305mm) and a maximum of 30" (762mm) above adequate drains with sufficient side clearance for testing and maintenance. The installation shall be made so that no part of the unit can be submerged.

**Relief Valve Discharge Rates**

(Worst case condition - If 1st check or relief valve is lodged wide open)

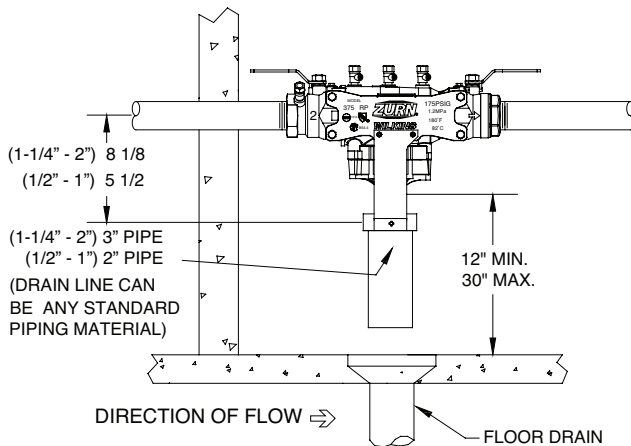
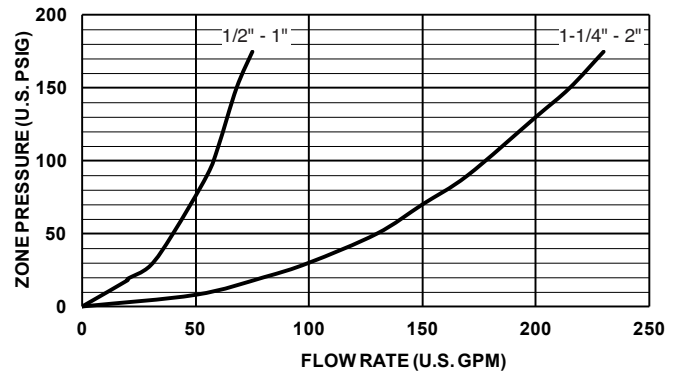

**INDOOR INSTALLATION**

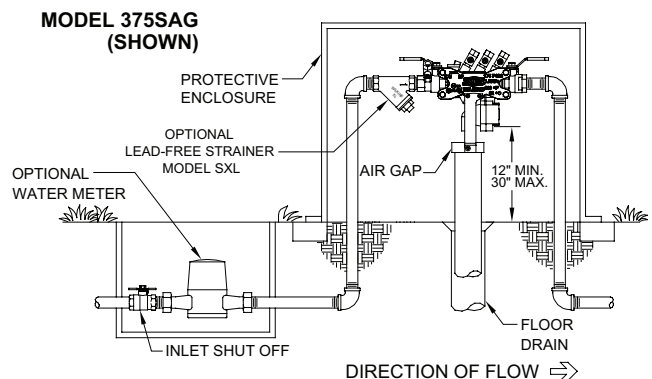

**OUTDOOR INSTALLATION**

**Specifications**

The Reduced Pressure Principle Backflow Preventer shall be ASSE® Listed 1013, rated to 180°F and supplied with full port ball valves. The main body shall be Nylon and the seat disc elastomers shall be silicone. If installed indoors, the installation shall be supplied with an air gap adapter. For non-potable applications only. The Reduced Pressure Principle Backflow Preventer shall be a ZURN WILKINS Model 375.