

Application

The Pressure-Tru™ Z2100 and Z2105 Series Pressure Reducing Valve is listed as a standpipe valve for individual hose stations in CLASS II systems. Regulates pressure under both FLOW and NO-FLOW conditions. Can be adjusted and set at the factory or set in the field without draining the standpipe riser.

Standards Compliance

- UL® Listed
- C-UL® Listed
- City of Los Angeles Approved

Material

Main valve body	Cast bronze ASTM B 584
Stem	Silicon bronze ASTM B 584
Flange	Navy "G" bronze ASTM B 584
Elastomers	Buna Nitrile (FDA approved) EPDM (FDA approved)
Springs	Chrome silicon, ASTM A 401 powder coated

Options

(Suffixes can be combined)

- Z2100 - female NPT inlet and male hose outlet
- C/C - with cap and chain
- CH - with chrome finish
- ST - with specified hose thread
- Z2105 - female NPT inlet and outlet angle valve

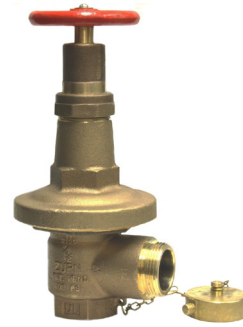

Z2100C/C



Z2105

Features

Sizes:	1 1/2"
Maximum inlet pressure	400 psi
Inlet connection	FNPT
Outlet connection (Z2100)	Male hose
Outlet connection (Z2105)	FNPT
Factory or Field Set	

Typical Installation

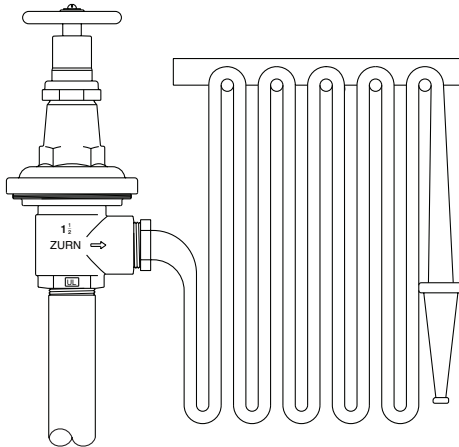

Model Z2105

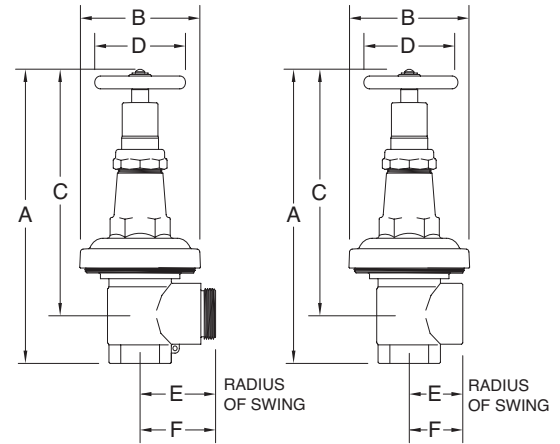

Model Z2100

Model Z2105

DIMENSIONS & WEIGHTS (do not include pkg.)

MODEL	DIMENSIONS (approximate)																	
	A OPEN		A CLOSED		B		C OPEN		C CLOSED		D		E		F		WEIGHT	
	in.	mm	in.	mm	in.	mm	in.	mm	in.	mm	in.	mm	in.	mm	in.	mm	lbs	kg
Z2100	11 1/2	292	11 1/4	286	5 1/4	133	9 3/4	248	9 1/2	241	4	102	3 1/2	83	3 1/4	89	13	6
Z2105	11 1/2	292	11 1/4	286	5 1/4	133	9 3/4	248	9 1/2	241	4	102	2 3/4	70	2 1/2	64	14	6.4

Residual Pressure Charts

For Pressure-Tru™ 1 1/2" Angle Valves

Models: Z2100 & Z2105

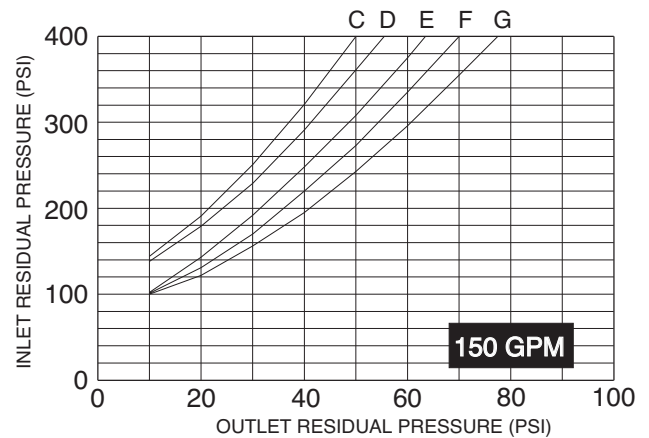
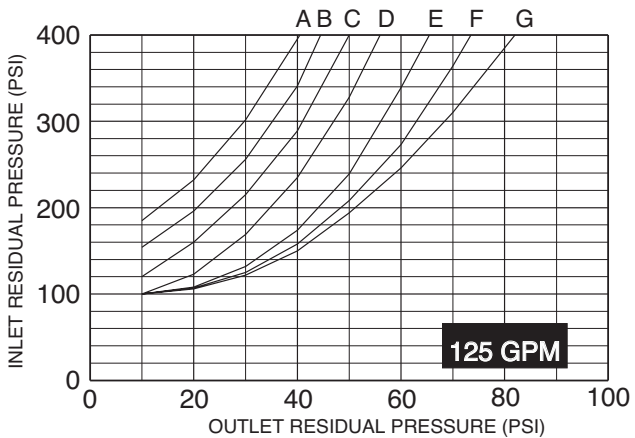
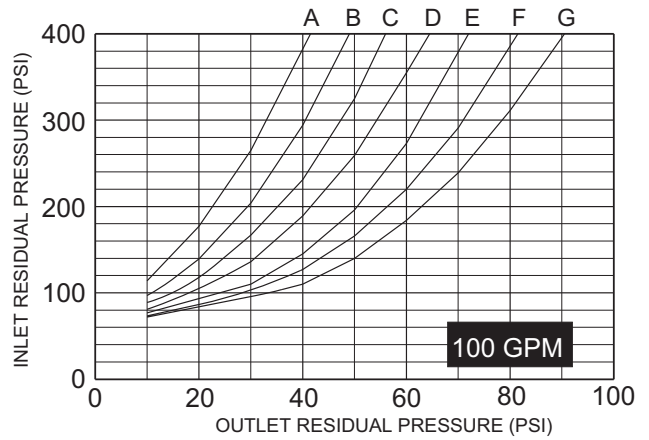
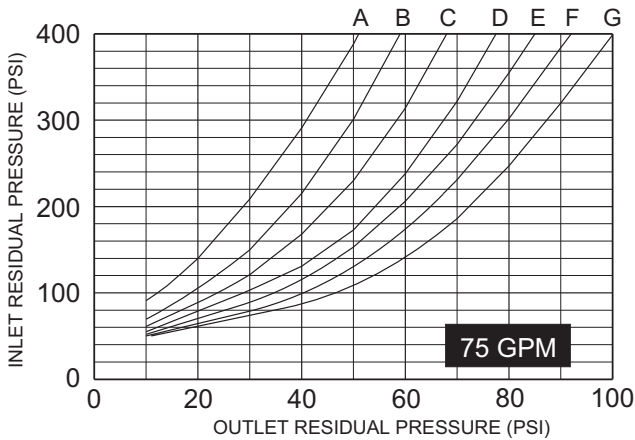
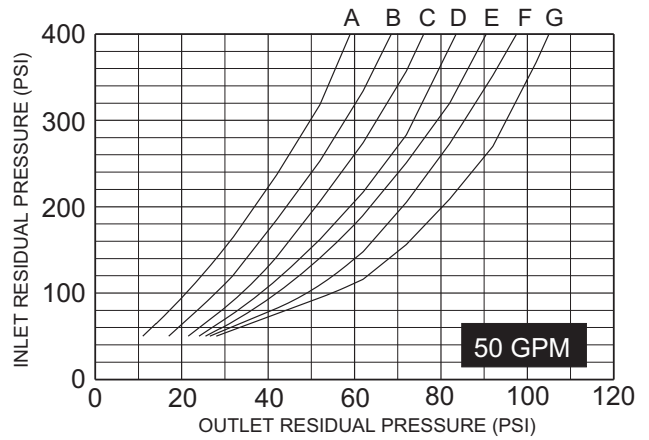
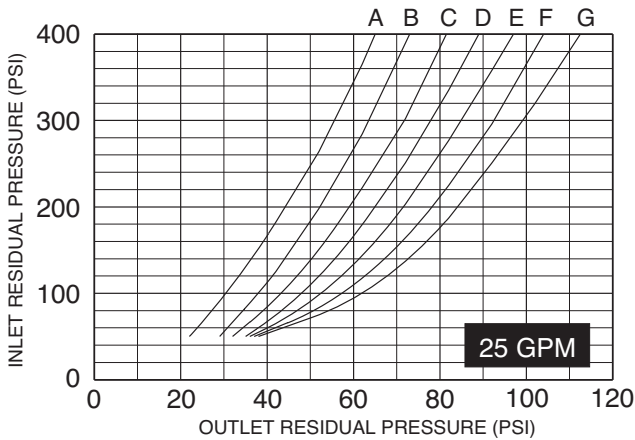

"A" DIMENSION SETTINGS (inches)						
A	B	C	D	E	F	G
3/16	1/4	5/16	3/8	7/16	1/2	9/16
NOTE: Curve accuracy= ±5 PSIG						

Residual Pressure Charts

For Pressure-Tru™ 1 1/2" Angle Valves

Models: Z2100 & Z2105

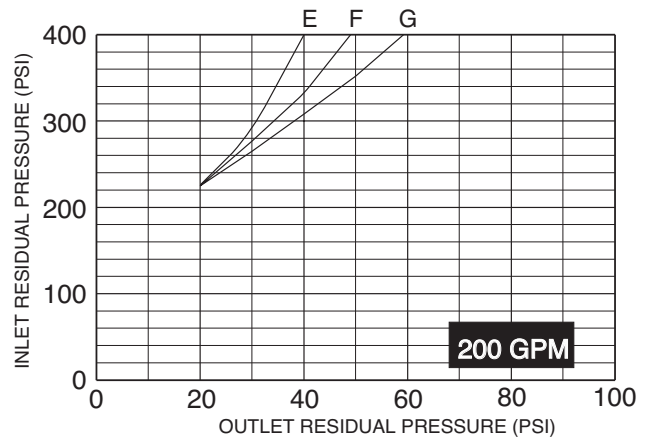
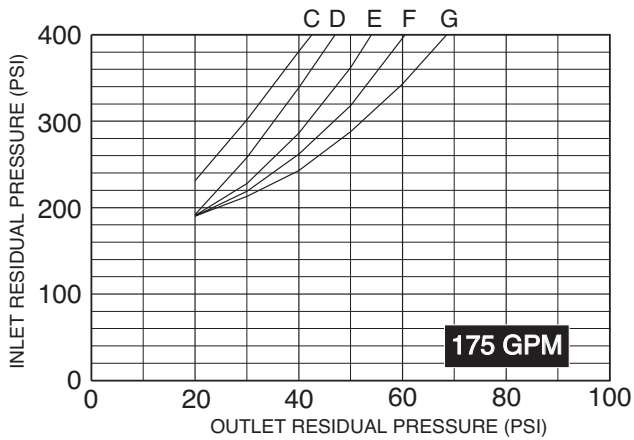

"A" DIMENSION SETTINGS (inches)						
A	B	C	D	E	F	G
3/16	1/4	5/16	3/8	7/16	1/2	9/16
NOTE: Curve accuracy= ±5 PSIG						

STATIC PRESSURE CHART

For ZURN Pressure-Tru™
Angle Valves
(1-1/2" Inlet and Outlet)

MODELS:
Z2100 and Z2105

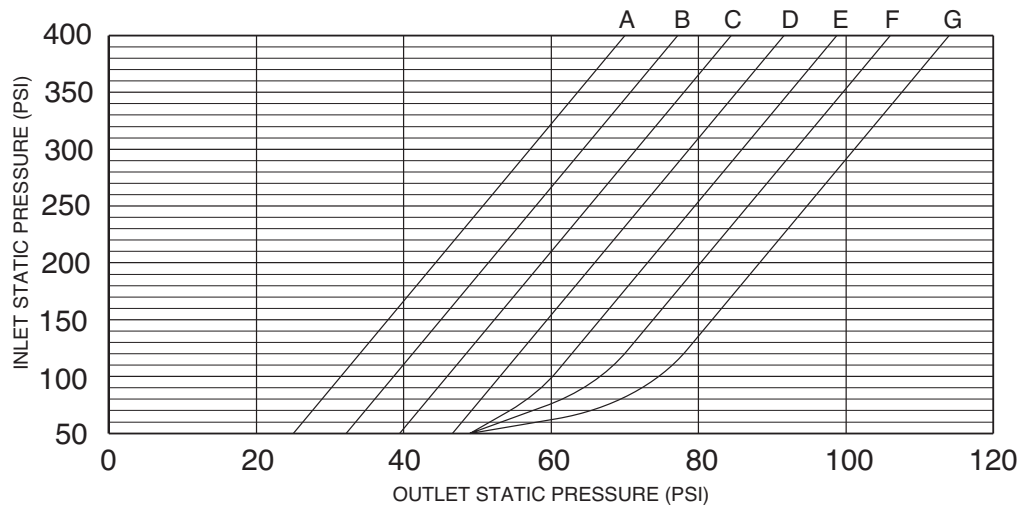

"A" DIMENSION SETTINGS (inches)						
A	B	C	D	E	F	G
3/16	1/4	5/16	3/8	7/16	1/2	9/16
NOTE: Curve accuracy= ±5 PSIG						