

WYNDHAM COLLECTION

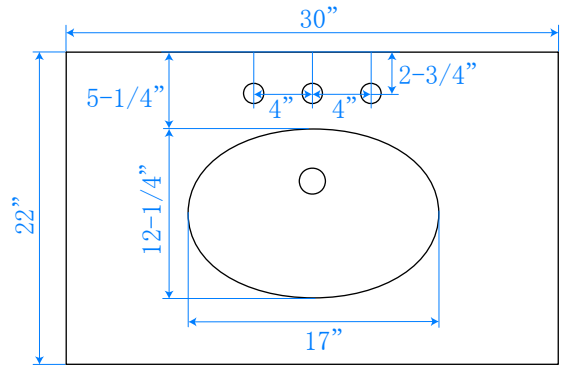

TOP VIEW OF VANITY CABINET

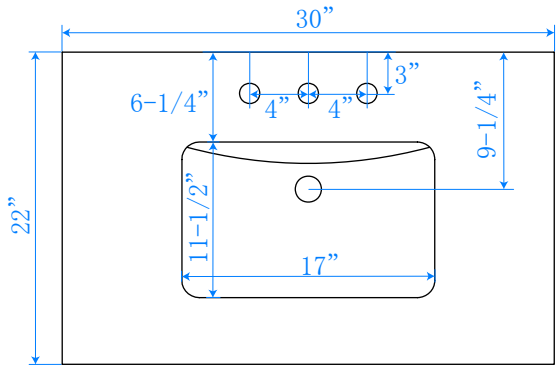
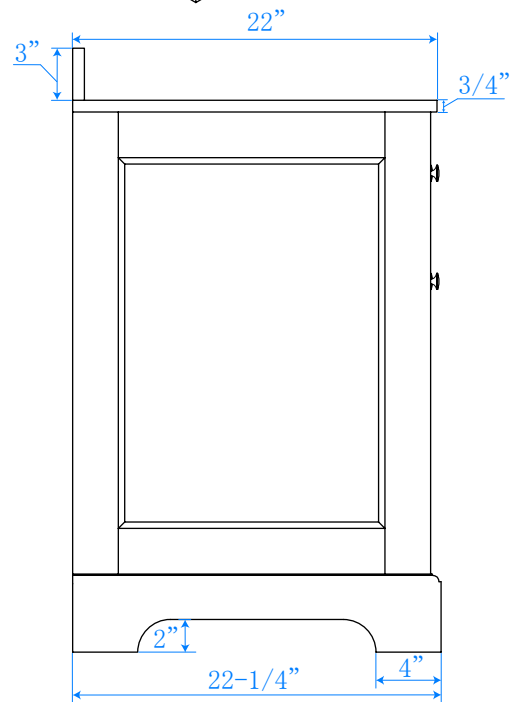
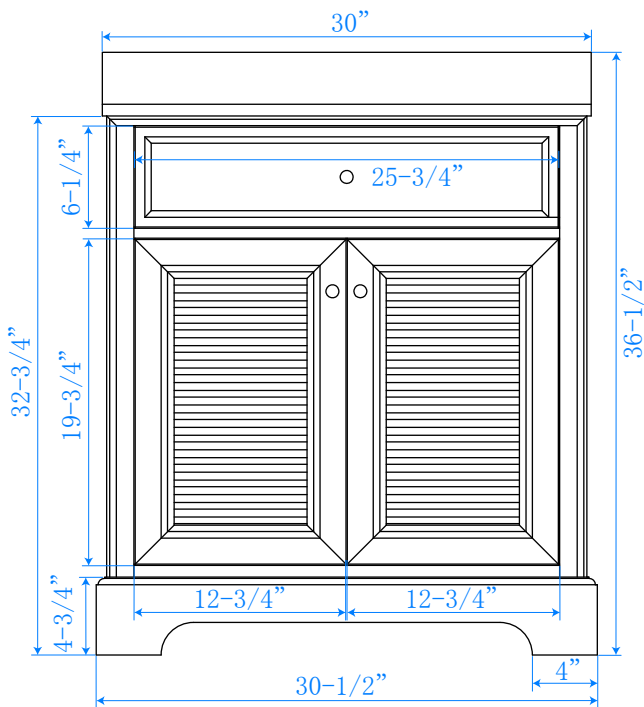
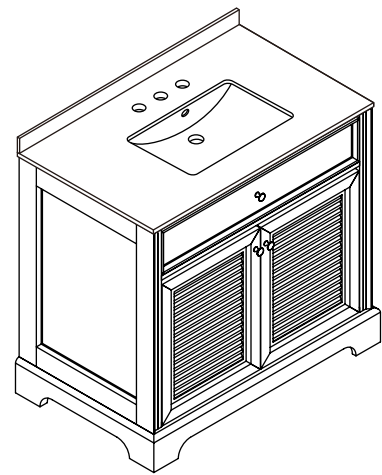
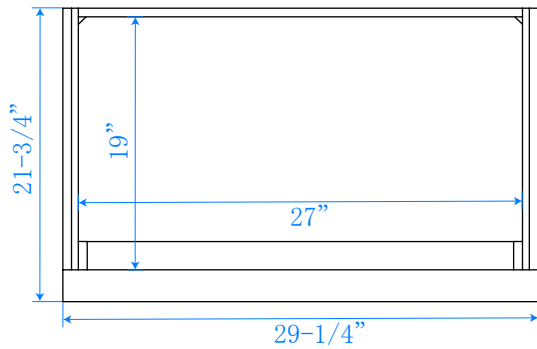

*Note: All Measurements are $\pm 1/4$ "

WC-2121-30