

37-7.4-BL3

Deck Mounted 2 Hole Kitchen Set

Includes Side Spray

Faucet Flow Rate: 1.75 GPM

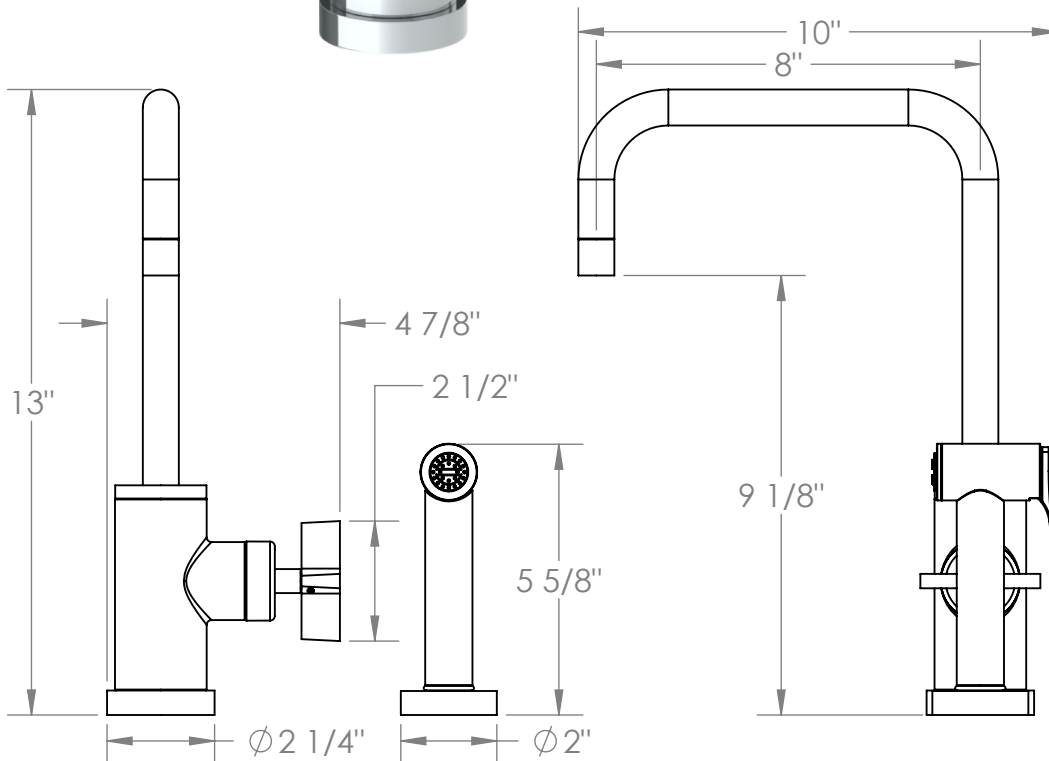

Meets the applicable requirements of ASME A12.18.1-2005/CSA B125.1-05, entitled "Plumbing Supply Fittings"