

23-7.1EG-L9

Deck Mounted 4 Hole Kitchen Set with Extended Gooseneck Spout and Side Spray
Faucet Flow Rate: 1.75 GPM

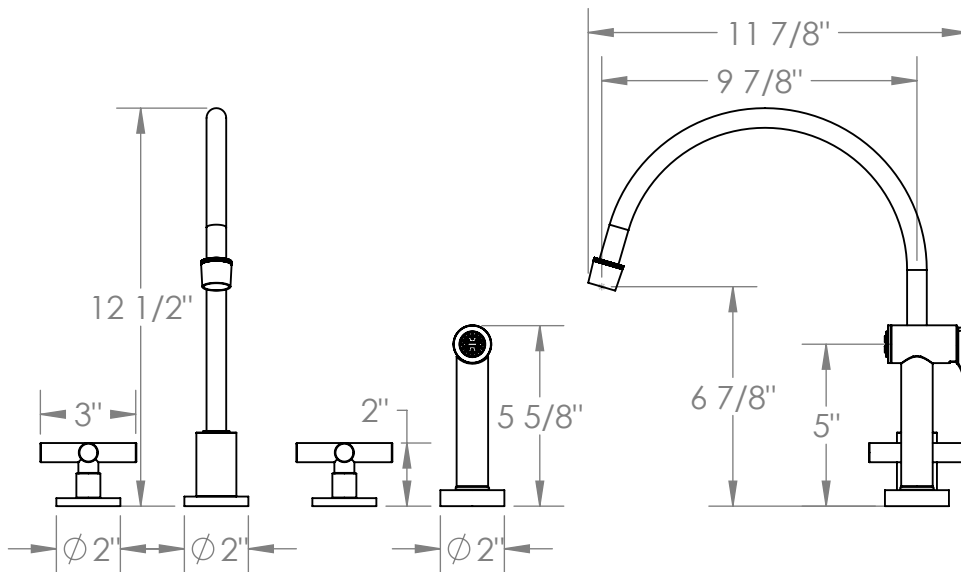

Meets the applicable requirements of ASME A112.18.1-2005/CSA B125.1-05, entitled "Plumbing Supply Fittings"

WATERMARK DESIGNS 8/23/2019

350 Dewitt Ave Brooklyn NY 11207 USA T 718 257 2800 F 718 257 2144 info@watermark-designs.com