

**23-7.1.3EG-L9**

Deck Mounted 2 Hole Kitchen Set with an Extended Gooseneck Spout  
Flow Rate: 1.75 GPM

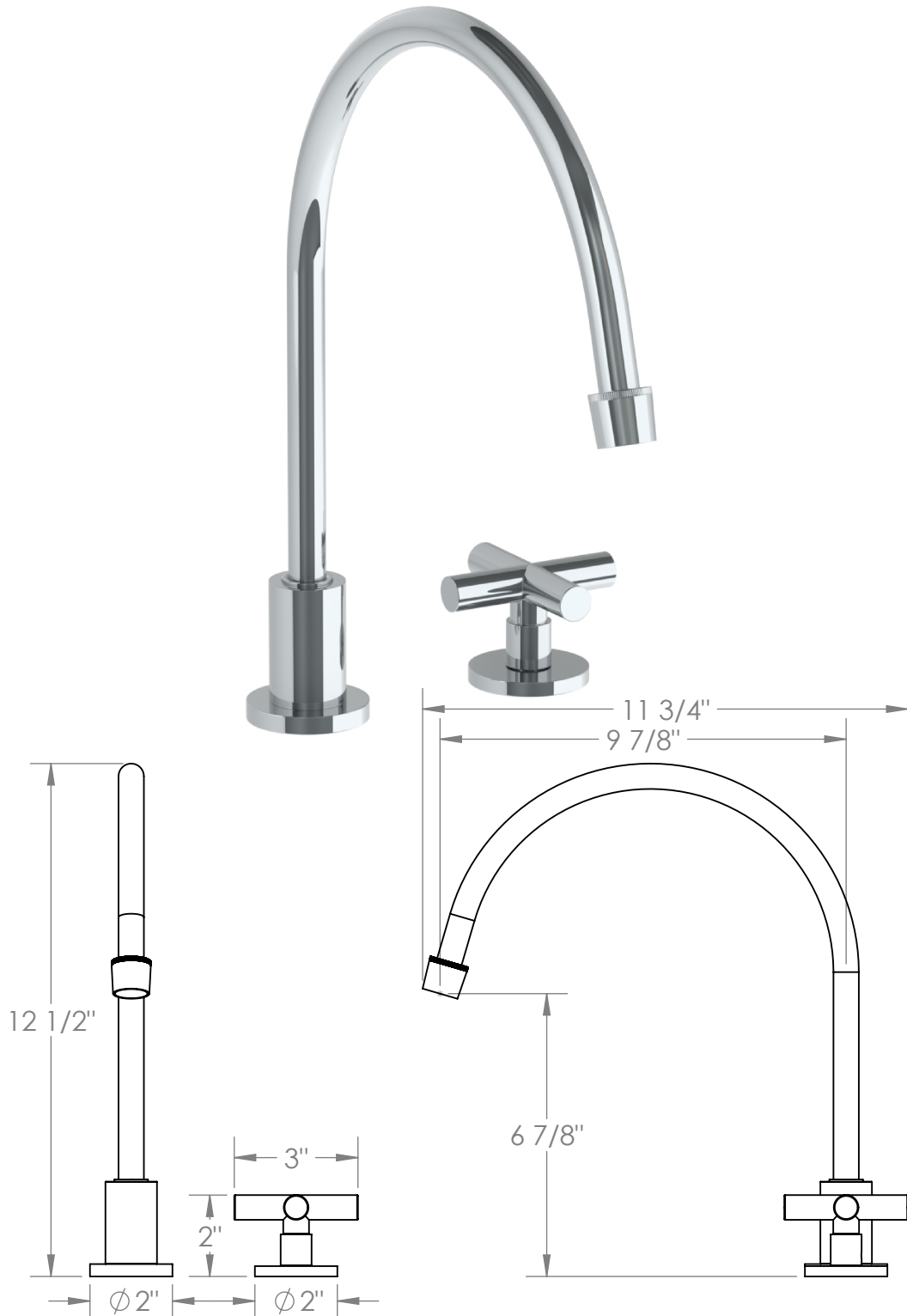

Meets the applicable requirements of ASME A112.18.1-2005/CSA B125.1-05, entitled "Plumbing Supply Fittings"