

**322-0.4**  
Paper Holder

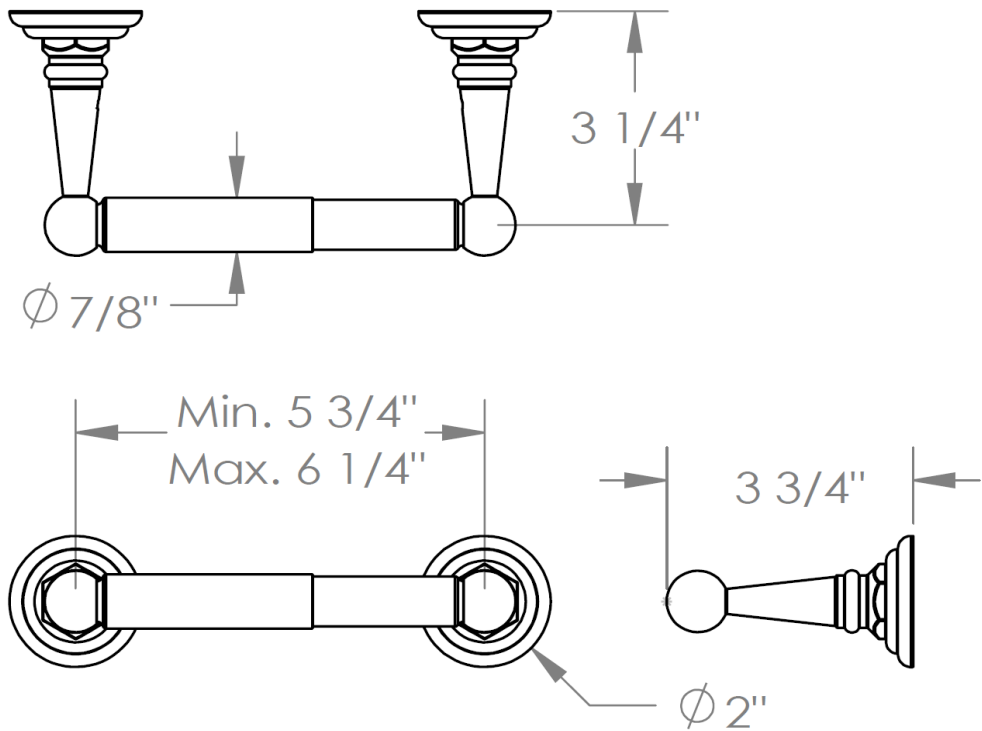

**WATERMARK DESIGNS 1/21/2015**