

# WATERMARK

BROOKLYN, NEW YORK

## Stratford 321-7PG2-S1

Deck Mounted, Two Handle, Gooseneck Faucet  
with Pull Down Spray



- Pullout Hose Length: 14-16" (Final Length May Vary Depending on Spout Type)
- Fits Deck Up To 2-1/2" Thick
- Recommended Mounting Hole: 1-3/8"
- All Lead-Free Brass Construction
- Flow Rate: 1.75 GPM
- 1/4 Turn Ceramic Cartridge
- 2 Flow Patterns, Aerated and Spray, Controlled By One Button
- 360° Rotating Spout with Magnetic Docking for Spray
- Professional Installation Required

Available in all finishes shown on the [Watermark Designs website](https://www.watermark-designs.com)

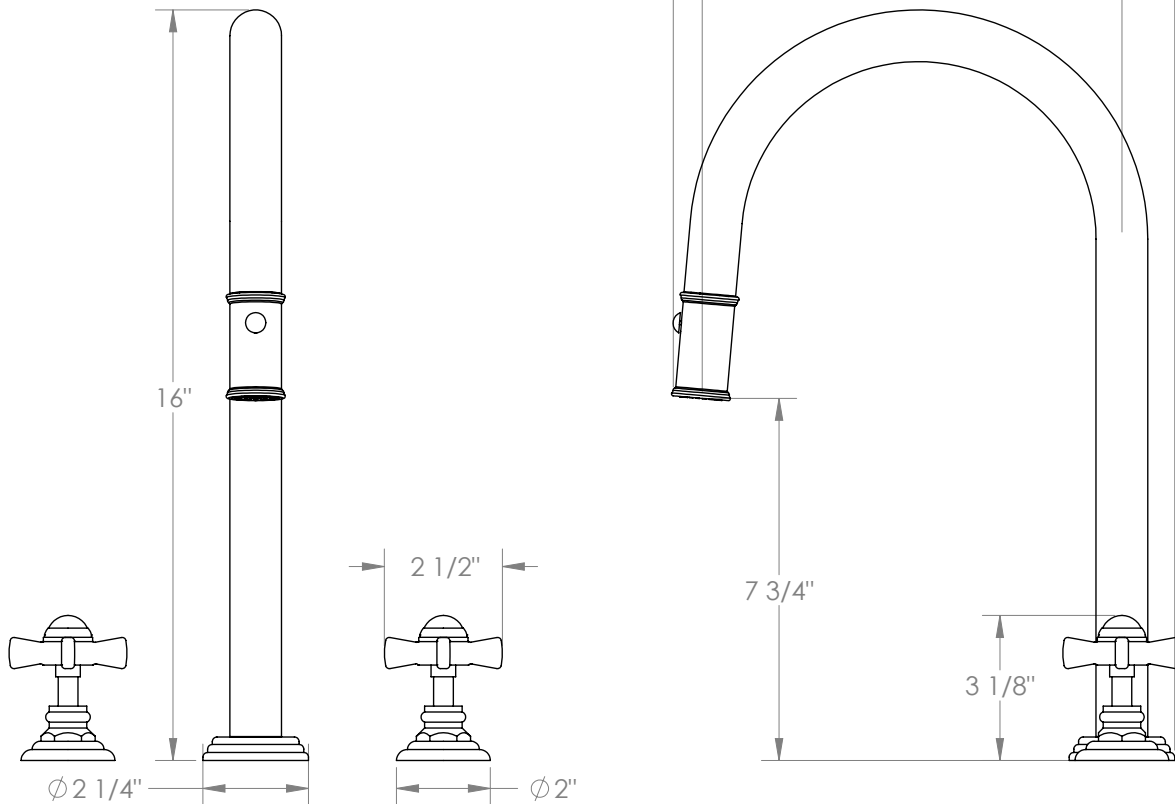

Meets the applicable requirements of ASME A112.18.1-2005/CSA B125.1-05, entitled "Plumbing Supply Fittings".

Watermark Designs reserves the right to make revisions without notice to produce specifications. All product dimensions are nominal.

09/2023

350 Dewitt Ave. Brooklyn, NY 11207 USA | T: 1 718 257 2800 | F: 1 718 257 2144 | [customerservice@watermark-designs.com](mailto:customerservice@watermark-designs.com)