

**25-1.3G-IN16**

Deck Mounted 2 Hole Lavatory Set with Gooseneck Spout  
Includes MPU7 pop-up drain  
Flow Rate: 1.2 GPM

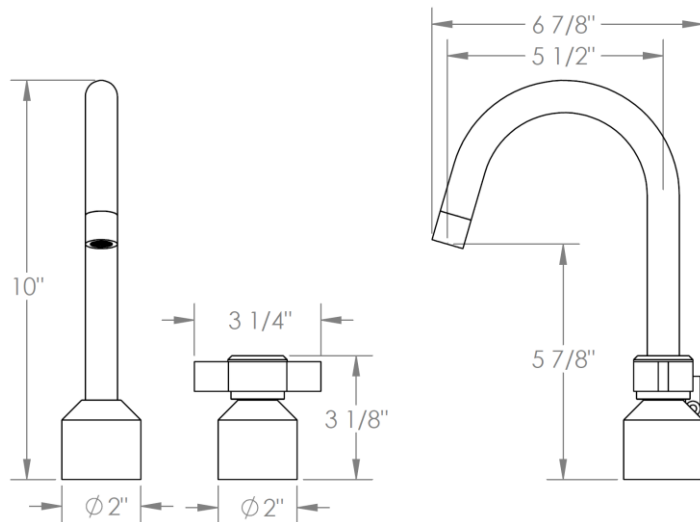

Meets the applicable requirements of ASME A112.18.1-2005/CSA B125.1-05, entitled "Plumbing Supply Fittings"

**WATERMARK DESIGNS 1/15/2019**

350 Dewitt Ave Brooklyn NY 11207 USA T 718 257 2800 F 718 257 2144 info@watermark-designs.com