

### 133-1.2-ja6

Wall Mounted 2 Hole Lavatory Set  
For use with SS-THV2.2 concealed rough  
Flow Rate: 1.2 GPM

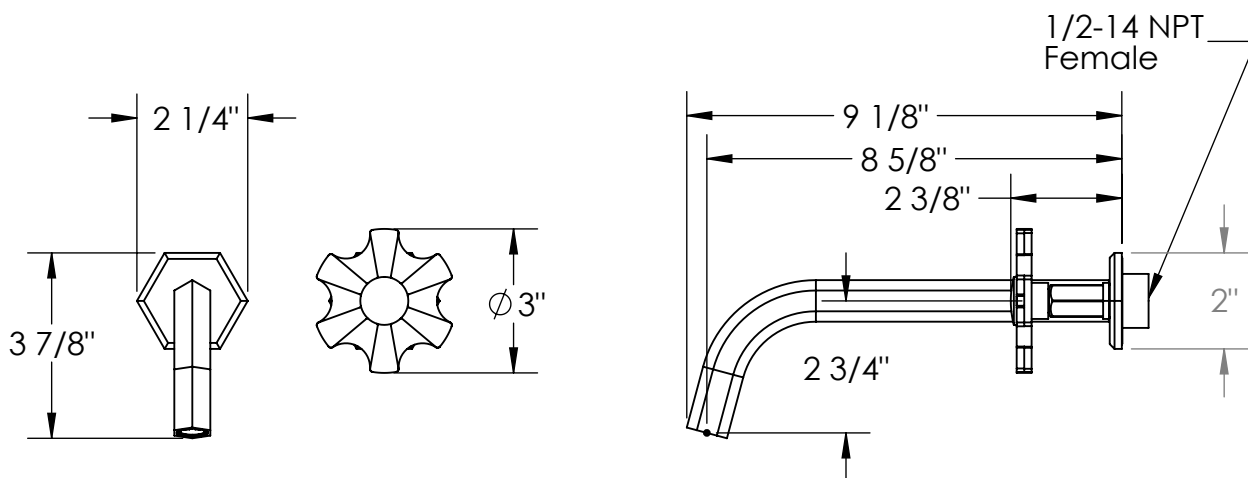

Meets the applicable requirements of ASME A12.18.1-2005/CSA B125.1-05, entitled "Plumbing Supply Fittings"

**WATERMARK** DESIGNS 6/30/2020

350 Dewitt Ave Brooklyn NY 11207 USA T 718 257 2800 F 718 257 2144 info@watermark-designs.com