

INSTALLATION INSTRUCTIONS



For more information contact...

WOODFORD MANUFACTURING COMPANY

2121 Waynoka Road, Colorado Springs, Colorado 80915 • Phone: (800) 621-6032 • Fax: (800) 765-4115

To view our complete product line visit: www.woodfordmfg.com or email: sales@woodfordmfg.com

A Division of WCM Industries, Inc.

Rev 08/12 Form No. II65.103

Model 65 & 67 Automatic Draining Wall Hydrant



Model 65 with Single Check Vacuum Breaker



Model 67 with Double Check Backflow Preventer

FIGURE 1

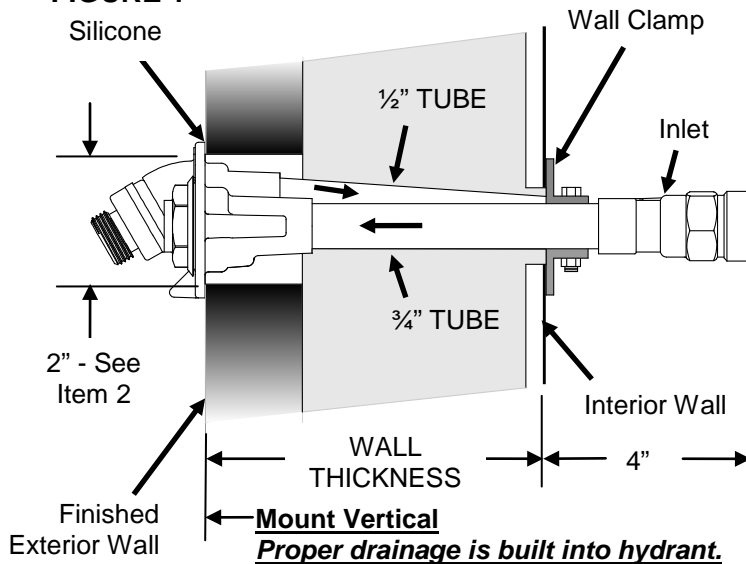
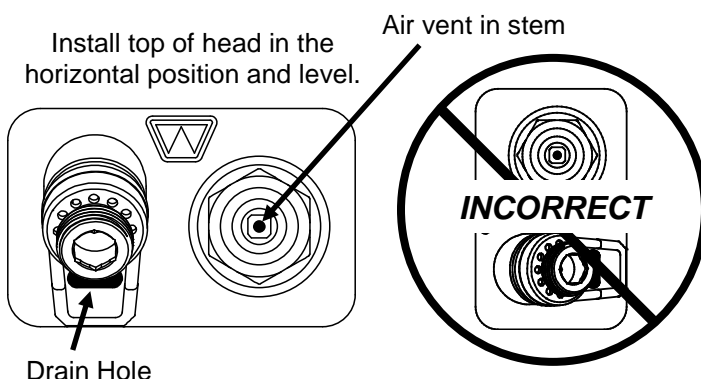

FIGURE 2



The hydrant must be properly installed and operated to insure drainage. Improperly installed or operated hydrants may freeze and burst in freezing weather.

INSTALLATION INSTRUCTIONS:

1. Before installation, flush supply line to remove any debris.
2. Cut a 2" X 3 7/8" opening through the wall in the desired location and insert the faucet from the outside. FIGURE 1
3. Install top of head in the horizontal position and level. *Do not install in vertical position.* FIGURE 2
4. *Note: Proper drainage is built into hydrant: FIGURE 1 (1/2" tube must slope slightly down toward inlet.) (3/4" tube must be level.)*
5. Apply silicone or equivalent to seal and help support hydrant FIGURE 1
6. Air vent in stem **must not** be plugged to ensure proper draining. FIGURE 2
7. Hydrant Inlet must be in a warm area. FIGURE 1
8. Install adjustable Wall Clamp over water tubes and slide snug to interior wall. FIGURE 1

Note: For solder connection, open hydrant to full open position before soldering. Excessive heat can damage valve seat rubber.

OPERATING INSTRUCTIONS:

To **OPEN**, turn stem counter-clockwise

To **CLOSE** and **DRAIN**, turn stem clockwise until seated and water drains out the drain hole.

INSTALLATION INSTRUCTIONS



For more information contact...

WOODFORD MANUFACTURING COMPANY

2121 Waynoka Road, Colorado Springs, Colorado 80915 • Phone: (800) 621-6032 • Fax: (800) 765-4115

To view our complete product line visit: www.woodfordmfg.com or email: sales@woodfordmfg.com

A Division of WCM Industries, Inc.

Rev 08/12 Form No. IIB65.102

Model B65 & B67 Box Type - Automatic Draining Wall Hydrant



Model B65 with Single Check Vacuum Breaker



Model B67 with Double Check Backflow Preventer

FIGURE 1

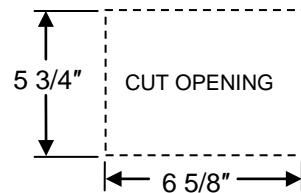

FIGURE 2

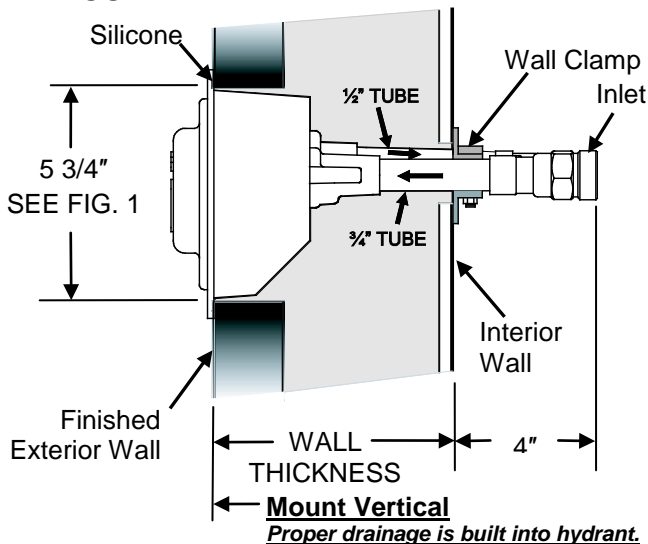
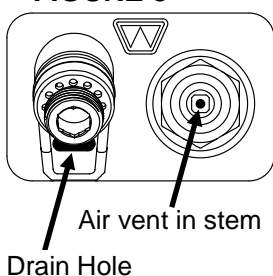

FIGURE 3



Drain Hole



EXAMPLE: B65 or B67 installed in a block wall.

The hydrant must be properly installed and operated to insure drainage. Improperly installed or operated hydrants may freeze and burst in freezing weather.

INSTALLATION INSTRUCTIONS:

1. Before installation, flush supply line to remove any debris.
 2. Cut a 5 3/4" X 6 5/8" opening through the wall in the desired location. FIGURE 1
 3. Apply silicone or equivalent behind the box flange to seal and help support hydrant. FIGURE 2
 4. Insert the box and faucet assembly from the outside. FIGURE 2
 5. The top box flange must be installed in the horizontal position and level. *Do not install in vertical position.* FIGURE 2
- Note: Proper drainage is built into hydrant: (1/2" tube must slope slightly down toward inlet.) (3/4" tube must be level.)*
6. The hydrant Inlet must be located in a warm area of the building interior. FIGURE 2
 7. Install adjustable Wall Clamp over water tubes and slide snug to interior wall. FIGURE 2
 8. The operating stem air vent **must not** be plugged to ensure proper draining. FIGURE 3

Note: For solder connection, open hydrant to full open position before soldering. Excessive heat can damage valve seat rubber.

OPERATING INSTRUCTIONS:

Use Tee Key to lock/unlock door and operate hydrant. To **OPEN**, turn stem counter-clockwise. To **CLOSE** and **DRAIN**, turn stem clockwise until seated and water drains out the drain hole.

INSTALLATION INSTRUCTIONS



For more information contact...

WOODFORD MANUFACTURING COMPANY

2121 Waynoka Road, Colorado Springs, Colorado 80915 • Phone: (800) 621-6032 • Fax: (800) 765-4115

To view our complete product line visit: www.woodfordmfg.com or email: sales@woodfordmfg.com

A Division of WCM Industries, Inc.

Rev 08/12 Form No. IIMB65.101

Model MB65 & MB67

Box Type - Automatic Draining Wall Hydrant



Model MB65 or MB67
DOOR OPEN



Model MB65 or MB67
DOOR CLOSED

FIGURE 1

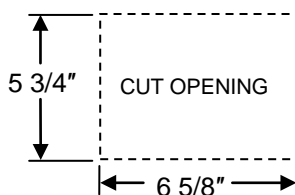
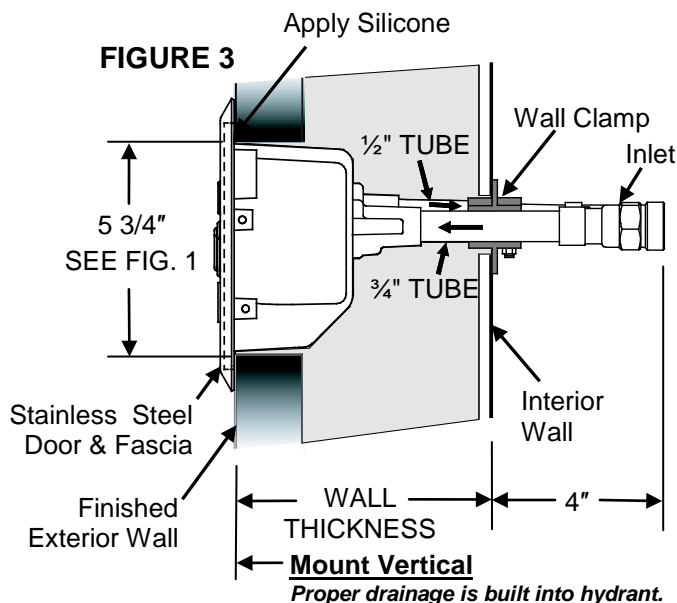

FIGURE 2



Air vent in stem
Drain Hole

FIGURE 3



The hydrant must be properly installed and operated to insure drainage. Improperly installed or operated hydrants may freeze and burst in freezing weather.

INSTALLATION INSTRUCTIONS:

1. Before installation, flush supply line to remove any debris.
2. Cut a 5 3/4" X 6 5/8" opening through the wall in the desired location. FIGURE 1
3. The operating stem air vent **must not** be plugged to ensure proper draining. FIGURE 2
4. Apply silicone or equivalent behind the box flange to seal and help support hydrant. FIGURE 3
5. Insert the box and faucet assembly from the outside. FIGURE 3
6. The top box flange must be installed in the horizontal position and level. *Do not install in vertical position.* FIGURE 3
Note: Proper drainage is built into hydrant: (1/2" tube must slope slightly down toward inlet.) (3/4" tube must be level.)
7. The hydrant Inlet must be located in a warm area of the building interior. FIGURE 3
8. Install adjustable Wall Clamp over water tubes and slide snug to interior wall. FIGURE 3

Note 1:

For solder connection, open hydrant to full open position before soldering. Excessive heat can damage valve seat rubber.

Note 2:

If desired, the stainless steel Door and Fascia assembly can be removed to prevent damage while installing the box hydrant unit. Open door and remove 4 screws inside of box.

OPERATING INSTRUCTIONS:

Use Tee Key to lock/unlock door and operate hydrant. To **OPEN**, turn stem counter-clockwise
To **CLOSE** and **DRAIN**, turn stem clockwise until seated and water drains out the drain hole.