

CG365T/S



FEATURES

Dual-stacked burners go from 18,000 Btu down to a mere breath of flame

Lower tier of dual-stacked burner lets you simmer and melt

Continuous cast-iron grates for easy movement of pots and pans

Easy-clean seamless burner pan

Rigorously tested in our U.S. manufacturing facilities for decades of use

Exceptional 24/7 support from our Customer Care team in Madison

Spark ignition system re-ignites if flame goes out

Stylish stainless control knobs capped in black

ACCESSORIES

2-Burner Wok Grate

36" Professional Grate Set

High altitude conversion kit

Accessories available through an authorized dealer.

For local dealer information, visit subzero-wolf.com/locator.



COOKTOP SPECIFICATIONS

- 3 - 9,200 Btu Burner
- 1 - 12,000 Btu Burner
- 1 - 18,000 Btu Burner

PRODUCT SPECIFICATIONS

Model	CG365T/S
Dimensions	36"W x 4"H x 21"D
Weight	67 lbs
Electrical Supply	120 VAC, 60 Hz
Electrical Service	15 amp dedicated circuit
Gas Supply	3/4" ID line
Gas Inlet	1/2" NPT female

ELECTRICAL

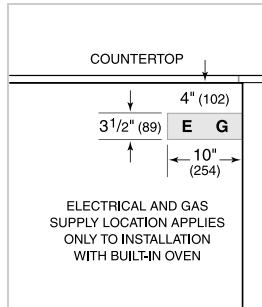

GAS

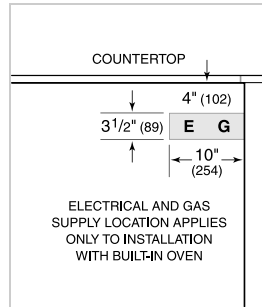

NOTE: Dimensions in parenthesis are in millimeters unless otherwise specified

DIMENSIONS

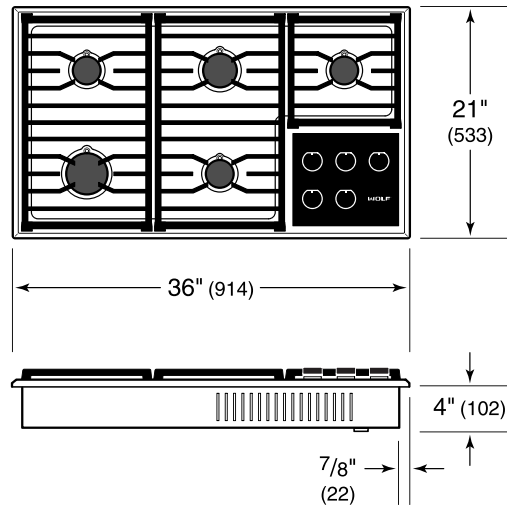

STANDARD INSTALLATION

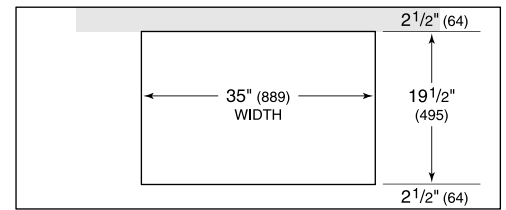

COUNTERTOP CUT-OUT

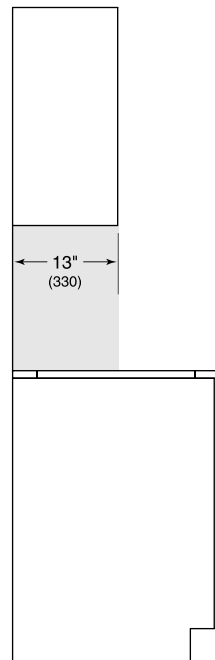

SIDE VIEW

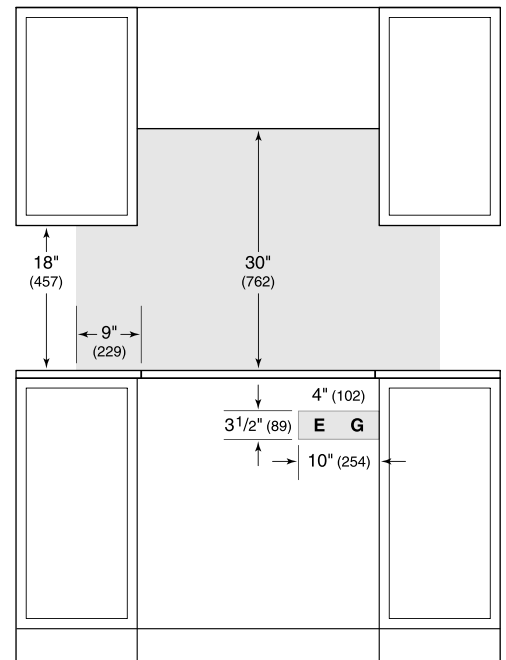

FRONT VIEW

NOTE: Shaded area above countertop indicates minimum clearance to combustible surfaces, combustible materials cannot be located within this area. Electrical and gas supply location only applies to installations with built-in oven.