

# 4iE

Smart WiFi Thermostat

## Installation & Operating Manual



For technical help:

US: (888) 927-6333

CA: (888) 592-7687

[warmup.com](http://warmup.com)

[warmup.ca](http://warmup.ca)

**Warmup**

Pack Contents .....	3
Mounting/Positioning.....	4
Wiring Connections .....	5
Assembling the 4iE.....	9
Getting Started.....	10
Registration .....	11
Welcome .....	13
Programming.....	14
Energy Monitoring.....	18
Troubleshooting .....	19
Settings.....	22
Important Notices.....	23
Technical Specifications.....	25

## 4iE

### Smart WiFi Thermostat

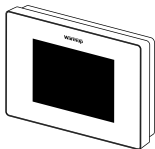

Thermostat Face

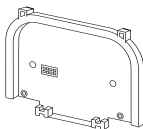

Back Plate



Floor Sensor

**IMPORTANT INFORMATION:** Installation should only be carried out by a qualified and competent electrician and must conform to local electrical code. Conduits are only required where it is mandated by state or provincial code. Please refer to local electrical code for compliant applications.

The 4iE and its power supply should be isolated from the mains supply throughout the installation process.

## 4iE

### Step 1 - Install Back Plate

Before making any permanent fixtures Warmup recommends identifying your preferred location for the 4iE. It should be located in an area with good ventilation. It should not be beside a window/door, in direct sunlight or above another heat generating device (e.g. radiator or TV).

Ensure the distance from your router to the 4iE is not too great. This will ensure the wireless connection is not subject to range or interference issues once installed.

1

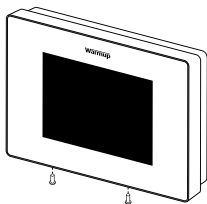

Loosen both screws at the bottom of the 4iE and remove the Back Plate.

2

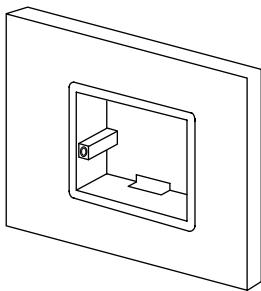

Install square  $2 \frac{3}{4}$ " deep back box with a single mud ring (also called plaster ring) in your preferred thermostat location.

## 4iE

## Step 2 - Wiring Connections



Isolate the thermostat from the mains supply throughout the installation process

## Heating Load connected to 4iE - Max. 15 Amps

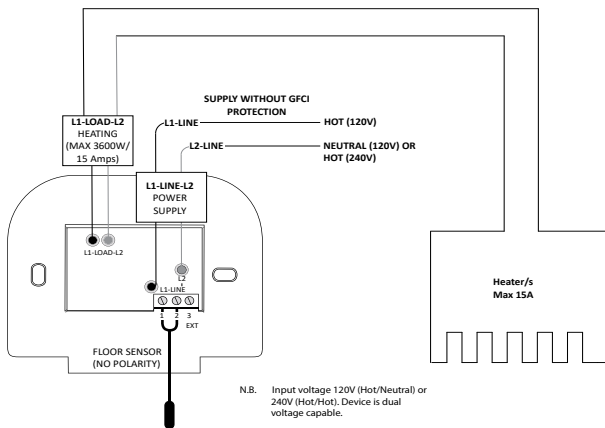

# 4iE

## Step 2 - Wiring Connections

### Heating Load connected to Relay 25 - Max. 25 Amps

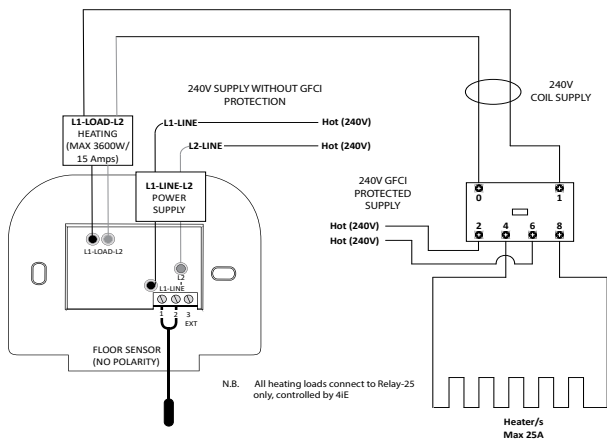

## 4iE

## Step 2 - Wiring Connections

## Heating Load connected to 4iE and Relay 25 - Max. 40 Amps

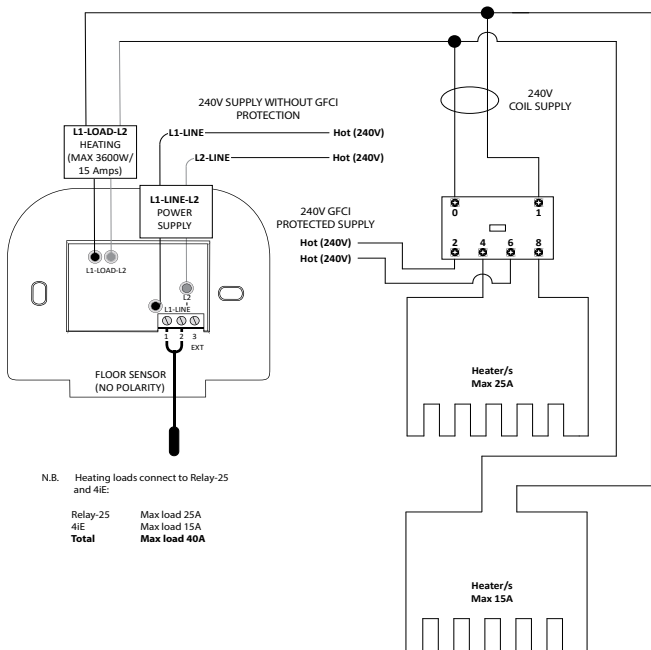

### 4iE

#### Step 2 - Wiring Connections

**Master/relay function:** Used to control loads greater than 15A. Heaters will be split across two 4iE's, one being the master and the other being the relay (slave). Only one floor sensor is required, wired into terminals 1 & 2 of the Master 4iE.

**Wiring Connections:** Use low voltage electrical cables to link terminals 2 & 3 of the Master and Relay.

**Thermostat Setup:** Settings > Adv. settings > Heater setting > Ext output

**NOTE:** Set the relay 4iE to relay first.



## 4iE

### Step 3 - Reattach 4iE Face

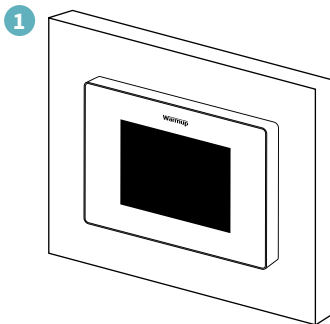

Reattach the 4iE face to the Back Plate and tighten both screws to secure. You may now restore power to the thermostat and begin setup.

# 4iE

## Step 4 - Getting Started

Depending on who has installed your 4iE, you will have one of the following screens visible. If you have anything other than the screens below, please press the standby button on the underside of Thermostat Face.

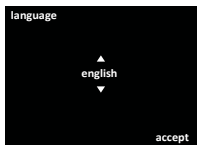

Language

If you have this screen present, the **Thermostat** has not been connected to a WiFi network.

Please follow the on-screen instructions to connect it to WiFi.

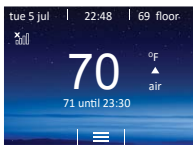

No WiFi

If you have this screen present, the **Thermostat** must be connected to a WiFi network.

> **Settings**  
> **Network**

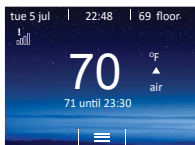

No Server

If you have this screen present, the **Thermostat** is connected to a WiFi network and you can continue to device registration.

Registration can be completed via the MyHeating App or by visiting [my.warmup.com](http://my.warmup.com).

## 4iE

### Step 5 - Download 'MyHeating' App

#### App Download

The **MyHeating** App is available for iOS and Android devices via the App Store or Google Play. If you have not done so already, download the "MyHeating" App to your tablet or smartphone.

#### Search 'MyHeating by Warmup'



#### Device Number

When first registering and setting up your location on **MyHeating**, you will need the device number of the **Thermostat**. Your installer should have recorded it below, if not it can be found in the **Thermostat** menu:

> Settings > Advanced settings > About > Info

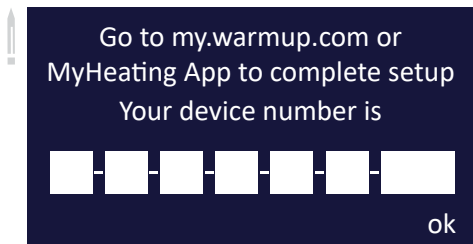

## 4iE

### Step 6 - Registering your device

#### Registration

Once the App has been successfully downloaded and device number recorded you will need to set up your MyWarmup account. The **Thermostat** can be registered via the **MyHeating App** or by visiting **my.warmup.com**

Below shows the menu structure to follow, when first registering with the **MyHeating App** or **my.warmup.com**

#### Location

A location needs to be setup before a room can be configured and the 4iE device registered. Creating a location is user friendly and easy to follow. It is advised to have details of your current energy tariff and pricing to hand, as these will be required for the energy monitoring features.

#### Room

With a location now setup, the next step is to register a room. When creating a new room, you must enter the following information:

Location	(Select the newly setup location)
Room name	(Description, e.g. Upstairs Bathroom)
Room type	(Select the room type e.g. Bathroom)
Floor type	(Select the floor type e.g. Tile/stone)
Device number	(See page 11)
System type	(Select e.g. 'Electric Underfloor')
System power	(Size of heat source e.g.1000W)
Power source	(Energy source e.g. gas/electricity)

NOTE: Please ensure you enter the correct *System Type* and *Wattage* of heaters connected. If a relay has been installed please set *System Type* as *Electric + Relay*.



Once setup has been completed the thermostat will display the home screen. If you do not press any button for 1 minute the 4iE screen will dim and go into standby. To wake the 4iE just tap the screen or press the lock icon.

Press the button on the bottom of the device to put the thermostat in/out of standby mode. Hold the button for 3 seconds to turn the heating off.

The icons at the bottom of the screen are your WarmApps. These can be set up on [my.warmup.com](http://my.warmup.com) to show things like weather alerts.

## Custom Program

Setting a Custom Program allows you to set comfort temperatures at set times throughout the day.

1

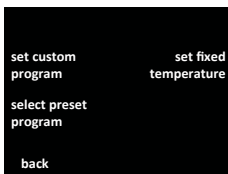

Press menu > Program > Set program > Set custom program.

2

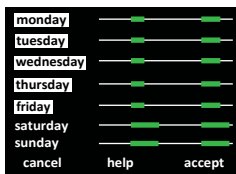

Select days of the week you wish to program.

3

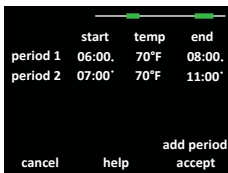

Select period 1 to begin programming.

4



Program the times and target temperatures of your custom schedule and press accept. Repeat for additional periods.

**Setback Temperature** - The setback temperature is defaulted to 61°F. To alter the setback Press Menu > Program > Set setback temperature.

## Preset Program

Select a Preset Program created by Warmup. See the summary of the Preset Programmes below.



Press menu > Program  
> Set program > Select  
preset program.

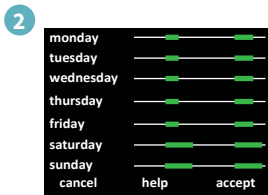

Press accept.

	Bathroom		Living Room		Bedroom		Kitchen	
	Time	Temp.	Time	Temp.	Time	Temp.	Time	Temp.
Mon-Fri	06:00	72°F			06:00	70°F	06:00	70°F
	08:00	61°F			08:00	61°F	08:00	61°F
	19:00	68°F	18:00	70°F	20:00	68°F	18:00	70°F
	23:00	61°F	21:30	61°F	23:00	61°F	22:00	61°F
Sat-Sun	07:00	72°F			06:00	70°F	07:00	70°F
	11:00	61°F			08:00	61°F	11:00	61°F
	18:00	68°F	08:00	70°F	20:00	68°F	18:00	70°F
	23:00	61°F	21:30	61°F	23:00	61°F	22:00	61°F

## Fixed Temperature

Set a fixed temperature for the thermostat to reach and maintain until you revert back to program mode or switch the heating off.

1

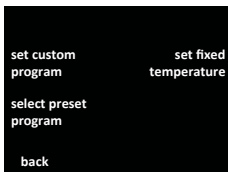

Press menu > Program > Set program > Set fixed temperature.

2

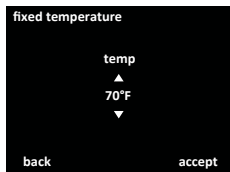

Set the target temperature and press accept.

## Temporary Override

Set a temperature you would like the thermostat to reach and the length of time you want this override to last.

1

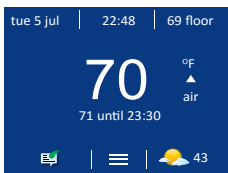

Press the temperature in the middle of the home screen.

Alternatively press menu > Temperature > Override.

2

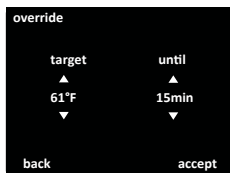

Set the target temperature, duration of override and press accept.



## Holiday Mode

Holiday Mode allows you to override your schedule with a lower fixed temperature over a set time to save energy.

1

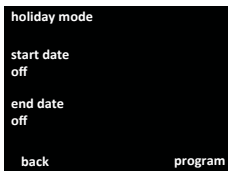

Press menu > Program > Holiday mode > Program.

2

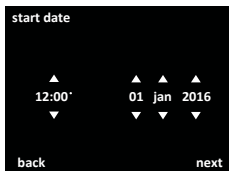

Set the holiday start time and date and press next.

3

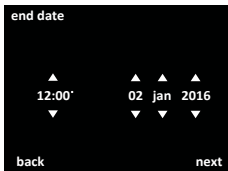

Set the holiday end time and date and press next.

4

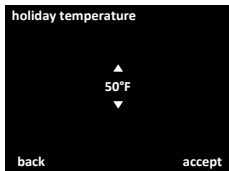

Set the holiday target temperature and press accept.

## Frost Protect

Select Frost Protect to set your heating to a constant 45°F to protect your home from frost. Press menu > Temperature > Frost protection.

## MyHeating App & MyWarmup Portal

You can also program your 4iE with your tablet or smartphone using the MyHeating App or by visiting [my.warmup.com](http://my.warmup.com)

## Energy Monitoring

The 4iE learns how you use your system and how your house reacts to the heating and weather. It can give you an estimate of your energy usage and the running cost of your system.

On initial set up, [Step 6](#), you will have entered the power (wattage) of your system and the cost per kilowatt hour charged by your energy provider. The 4iE will use this information to calculate the running cost of your system.

When you've set up the Energy Monitor you can view the estimated usage or cost over a selected time period. If you have a standard/low energy tariff, the amount and cost of energy used during the standard period will be displayed in dark green and the amount used in the low period will be displayed in light green.

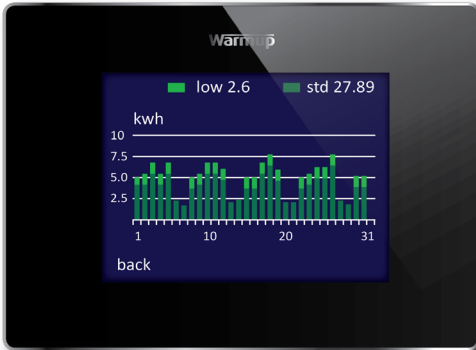

# 4iE

## Troubleshooting

<p>Display is blank</p>	<ol style="list-style-type: none"> <li>1. Check that the display/standby brightness is not on the lowest settings '0'.</li> <li>2. <b>(Electrician Required)</b> Electrician required to verify power is going to the 4iE and that it is correctly wired.</li> </ol>
<p>"er1" or "er2" is displayed</p>	<ol style="list-style-type: none"> <li>1. <b>(Electrician Required)</b> Electrician required to verify that the floor sensor has been wired correctly. If it is correctly wired the electrician will need to check the resistance of the floor sensor using a multi meter. For temperatures between 68°F and 86°F the resistance of the floor sensor should measure between 8K ohms and 12K ohms.</li> </ol> <p>If the electrician finds a fault, and the 4iE is in the room to be heated then it can be set into "Air Mode". (Air Mode only suitable for tiled floors if floor sensor has been damaged)</p>
<p>Heating is coming on earlier than the pre-programmed times</p>	<ol style="list-style-type: none"> <li>1. The 4iE "Early Start" function is on. This means that the heating will come on early to achieve the set temperature at the set time.</li> </ol>
<p>I cannot to set above a certain temperature</p>	<ol style="list-style-type: none"> <li>1. Delicate floor coverings need to have their temperatures limited. If the finished floor is set for wood, laminate, vinyl etc. you are unable to set the temperature above 81°F.</li> </ol>

## 4iE

### WiFi Troubleshooting

Before following the troubleshooting guide below please check the following:

1. The password is WPA2 protected
2. The router is set to a 2.4 GHz band (802.11 b, g, n, b/g mixed, b/g/n mixed)

**NOTE:** If you need to change any of the items listed above, please contact your ISP.

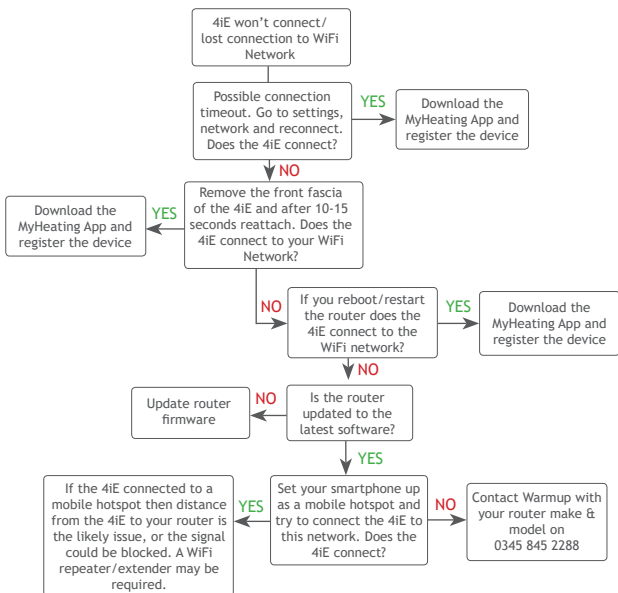

# 4iE

## Server Troubleshooting

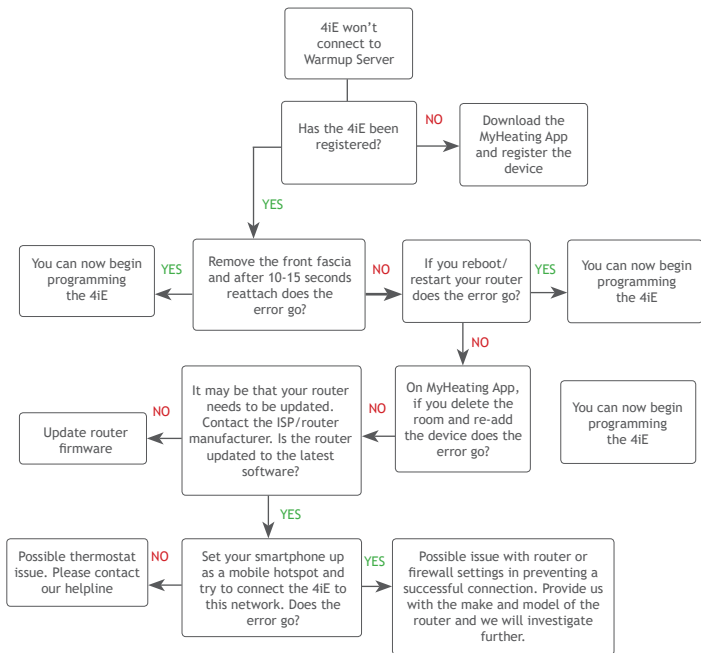

### Time

Set time	Manually set time
Set date	Manually set date
Daylight savings	Set daylight savings (europe/n.america/australia/off)

### Heating preference

Temperature format	Celsius/fahrenheit
Control air/floor	Use air or floor sensor as heating target
Early Start	Starts heating early so it's up to temperature at the right time

### Display/Audio

Background	Change the background screen (upload your own via MyHeating App or by visiting <a href="http://my.warmup.com">my.warmup.com</a> )
Home screen style	Choose a theme for the main screen
Display brightness	Change the screen brightness for normal use and standby
Lock	Set a lock code
Audio	Feedback turn the 'click' sound on/off

### Network

Choose a WiFi network

## Advanced Settings

### Heater Settings

Heating Limits	Set the temperature limits for your floor type. User Defined lets you set custom limits
Regulator	Controls the heating in 10 minute cycles. The number you enter is the number of minutes in a 10 minute cycle that the heating will be on
Ext Output	This allows one thermostat to control another

### Probes

Set the specification of the probes or set to 'none' to hide the probe on the homescreen

### Probe application

Choose if the floor probe is being used as a Floor or Amb (ambient) sensor

### Offset

Set the offset of the sensors to improve accuracy

### Reset

This will restore all the factory default settings

## FCC Notice

This device complies with Part 15 of the FCC Rules. Operation is subject to the following two conditions: (1) this device may not cause harmful interference, and (2) this device must accept any interference received, including interference that may cause undesired operation.

Warning: Changes or modifications to this unit not expressly approved by the party responsible for compliance could void the user's authority to operate the equipment.

**NOTE:** This equipment has been tested and found to comply with the limits for a Class B digital device, pursuant to Part 15 of the FCC Rules. These limits are designed to provide reasonable protection against harmful interference in a residential installation. This equipment generates, uses, and can radiate radio frequency energy and, if not installed and used in accordance with the instructions, may cause harmful interference to radio communications. However, there is no guarantee that interference will not occur in a particular installation. If this equipment does cause harmful interference to radio or television reception, which can be determined by turning the equipment off and on, the user is encouraged to try to correct the interference by one or more of the following measures:

- Reorient or relocate the receiving antenna.
- Increase the separation between the equipment and receiver.
- Connect the equipment into an outlet on a circuit different from that to which the receiver is connected.
- Consult the dealer or an experienced radio TV technician for help.

**Caution:** To maintain compliance with the RF exposure guidelines, place the unit at least 20cm from nearby persons.

### IC Statement

This device complies with Industry Canada Licence-exempt RSS-247. Operation is subject to the following two conditions:

- (1) This device may not cause interference, and
- (2) This device must accept any interference, including interference that may cause undesired operation of the device.

**Caution:** To maintain compliance with the RF exposure guidelines, place the unit at least 20cm from nearby persons.

### Déclaration IC

Cet appareil est en conformité avec la licence Industrie Canada CNR-247. Son fonctionnement est sujet aux deux conditions suivantes:

- (1) Cet appareil ne doit pas causer d'interférences ; et
- (2) Cet appareil ne doit accepter aucun signal interférent, incluant les signaux pouvant perturber le fonctionnement dudit appareil.

**Attention:** Les consignes de fréquences radio requièrent l'installation à au moins 20cm des utilisateurs occupant la pièce.

### GFCI Notice

The GFCI feature is used to detect any leakage of current from your heating system. During a ground fault the two lines of the load will be cut off. Once your thermostat is installed and connected to a power supply you can test the GFCI function by increasing the set temperature until heating is on - the heating up icon (▲) will be illuminated - and pressing the "TEST" button. If your test is successful you will see the GROUND FAULT screen and you will need to hold "cancel" for 3 seconds in order to restore heating operation.

However if the thermostat detects that one of the relays has FAILED to open correctly you will see the CONTROL FAULT screen and the TEST LED will illuminate. In the following circumstances you should immediately isolate the power supply to the thermostat and contact our helpline:

1. Press the TEST button when heating is on (heating icon ▲ will be illuminated) and the screen does not display GROUND FAULT or cut power to the load.
2. The thermostat shows the GROUND FAULT screen during normal operation.
3. The thermostat shows the CONTROL FAULT screen.

**NOTE:** The GFCI test should be carried out monthly.



## 4iE

## Technical Specifications

Supply Voltage	120-240V AC 60Hz
Dimensions	3.54 x 4.72 x 0.70in
Screen size	2.7 x 2.5in
GFCI	Class A GFCI with 5mA trip level
Sensors	Air & Floor (Ambient)
Sensor Type	NTC10k 3m Long (Can Be Extended To 50m)
Max. Load	15A (3600W)
Installation Depth	2-3/4in deep double gang box recommended
Compatibility	Electric, Hydronic Underfloor Heating (up to 16A.)
Warranty	3 Year with optional Lifetime Upgrade
Approvals	ETL





# Contact Us

warmup.com

warmup.ca

US: (888) 927-6333

CA: (888)-592-7687

Email: us@warmup.com

## Warranty

Warmup plc warrants this product, to be free from defects in the workmanship or materials, under normal use and service, for a period of three (3) years from the date of purchase by the consumer. If at any time during the warranty period the product is determined to be defective, Warmup shall repair or replace it, at Warmup's option. If the product is defective, please either,

- (i) return it, with a bill of sale or other dated proof of purchase, to the place from which you purchased it, or
- (ii) contact Warmup. Warmup will determine whether the product should be returned, or replaced.

This warranty does not cover removal or re-installation costs, and shall not apply if it is shown by Warmup that the defect or malfunction was caused by failure to follow the instruction manuals, incorrect installation or damage which occurred while the product was in the possession of a consumer.

Warmup's sole responsibility shall be to repair or replace the product within the terms stated above.

WARMUP SHALL NOT BE LIABLE FOR ANY LOSS OR DAMAGE OF ANY KIND, INCLUDING ANY INCIDENTAL OR CONSEQUENTIAL DAMAGES RESULTING, DIRECTLY OR INDIRECTLY, FROM ANY BREACH OF ANY WARRANTY, EXPRESS OR IMPLIED, OR ANY OTHER FAILURE OF THIS PRODUCT. THIS WARRANTY IS THE ONLY EXPRESS WARRANTY WARMUP MAKES ON THIS PRODUCT. THE DURATION OF ANY IMPLIED WARRANTIES, INCLUDING THE WARRANTIES OF MERCHANTABILITY AND FITNESS FOR A PARTICULAR PURPOSE, IS HEREBY LIMITED TO THE THREE-YEAR DURATION OF THIS WARRANTY.

This Warranty does not affect your statutory rights.