

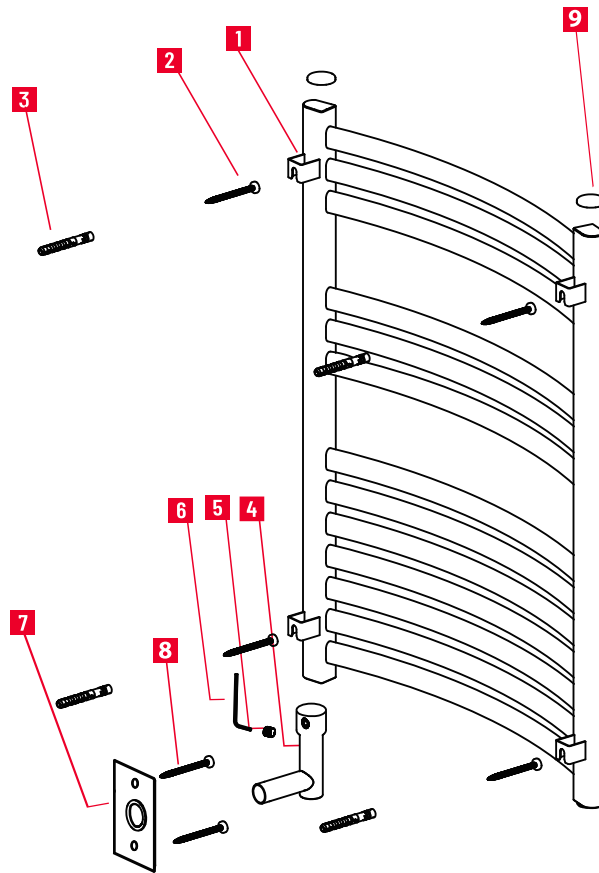











Towel
Warmers

ATLANTA Installation Guide





Accessories

- | | | |
|--|---|---|
| 1  Solid Fixing Lug
4 pcs | 4  Mounting Tube
1 piece | 7  Plate
1 piece |
| 2  Long Wall Screw
4 pcs | 5  Set Screws
1 piece | 8  Wall Plate Screws
2 pcs |
| 3  Plugs
4 pcs | 6  Allen Key
1 piece | 9  Plastic Cap
2 pcs |

Required Tools

STARHEAD SCREWDRIVERS



FLAT HEAD SCREWDRIVERS



MEASURING TAPE



DRILL & BIT

5/16" Diameter

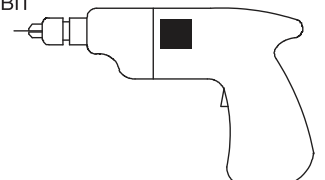

LEVEL



PENCIL

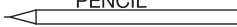

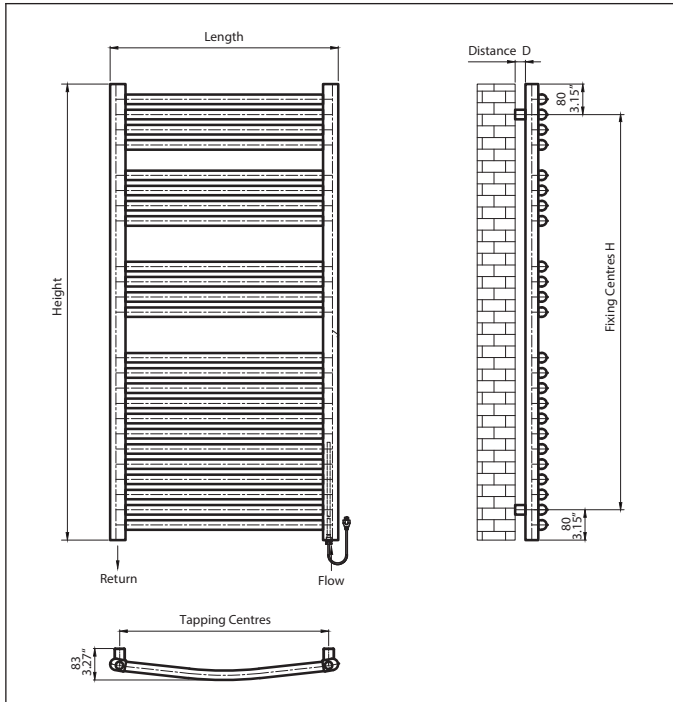

- All the dimensions are shown in millimetres/inch
- Horizontal Tube dia 25mm
- Vertical Tube 40mmx30mmxR51
- Bracket length – 27mm
- Rated 100, 150, 300 or 400W dependent on model
- Suitable for 120V supply, three wire connection
- The electric towel rails conform to: the requirements of UL499 CSA C22.2 No.60335-1 and E60335-2-43

Please Note:

- All towel warmers contain a factory – filled glycol mixture
- Not suitable for use on domestic hot water system
- Before starting, ensure situation and orientation

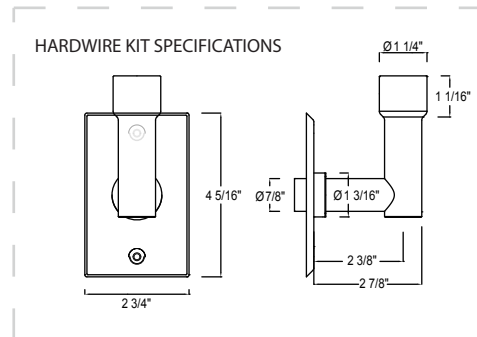

Vernon	Weight (KG)	Tapping Centres (mm)/inch	Fixing Centres (H) (mm)/inch	Distance (D) (mm)/inch	Height (mm)/inch	Length (mm)/inch
ATL-0800600	12.7	550/21.65"	640/25.2"	27/1.06"	800/31.5"	600/23.62"
ATL-1200600	18.9	550/21.65"	1040/40.94"	27/1.06"	1200/47.24"	600/23.62"

Step 1

Ensure the fixing lug (1) on the vertical bar on the back of the towel warmer.

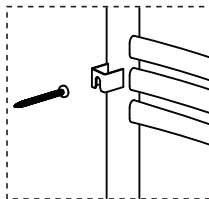

Step 2

Use a tape to measure the distance between the center points of each wall bracket tube; record the distances between points AB, AC, CD, and BD. Mounting point C will determine electrical box location. See Electrical Assembly in following instructions.

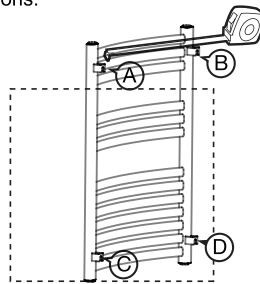

Step 3

Drill A, B, C, and D holes with an appropriately sized bit.

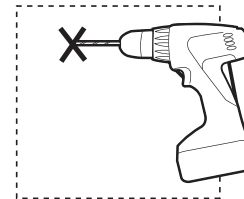

Step 4

Insert the wall screws (2) into plug (3)



Step 5

Install the tube onto the wall screw (2)

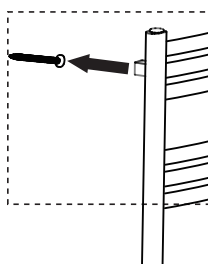

Step 6

Add the plastic caps onto the top to cover the screw head and valve.

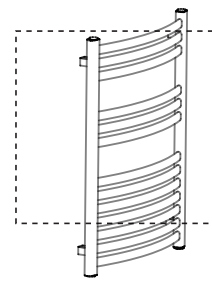

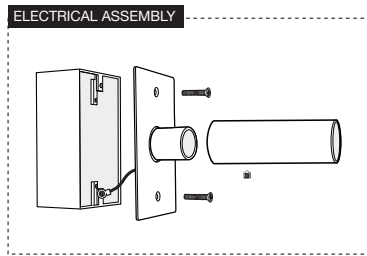

NOTE:

The power lead must be connected to a socket or connection block, which must be at least 25CM from the floor.

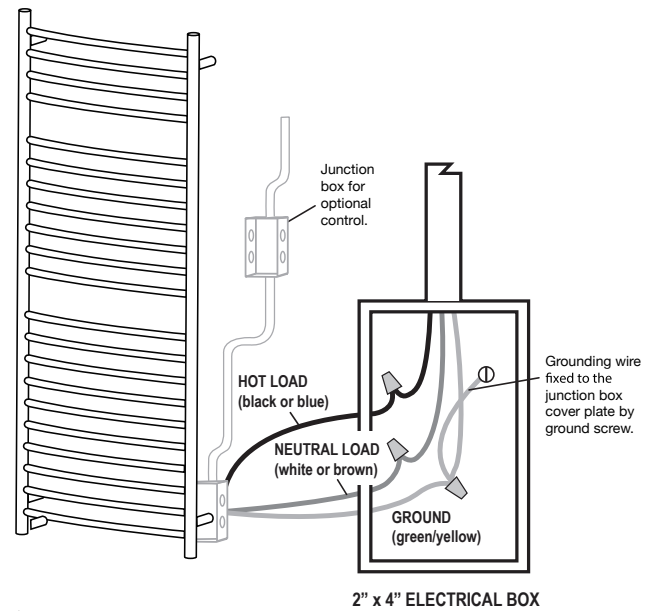
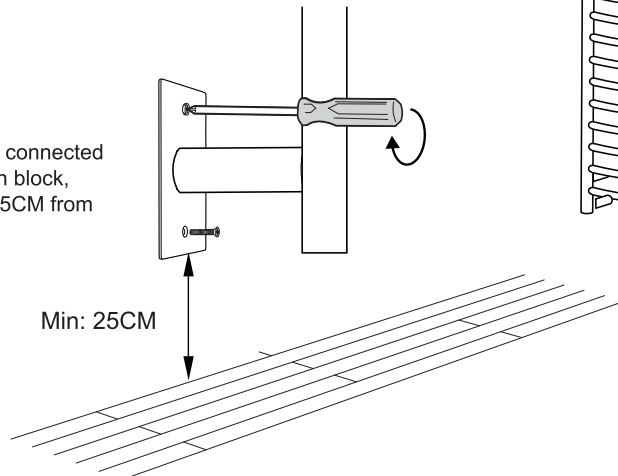

Step 7

Without Hardware Kit

Guide the electrical cord through the plastic cap and connect with electrical box.

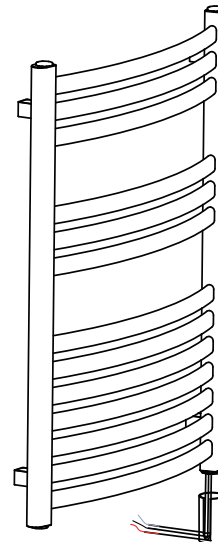

Step 8

With Hardware Kit

- Create a hole in the wall to let the Hard Wire Leg go through (approx. 2 in. x 3 3/4 in.).
- The leg will be covered by Plate so the hole should be large enough to allow space for electrical connection and leg to go through but not too large so that the plate can cover it fully.
- Guide the electrical cord through the electrical connection mounting tube and use the mounting screw to tighten the electrical connection mounting tube to the vertical bar.

