

OG002C

26.6x32.5

Height: 26.6
 Width: 32.5
 Depth: 5.3
 Weight HO: lbs (kg)
 EO: lbs (kg)

Tube ϕ : 1.25
 Output @ 50°C Δ T: 190
 Elec. element if specified: n/a
 Pipe Centres: 29.5

All dimensions in inches

Manufactured from ISO/CEN CuZn36As (BS CZ126) brass tube

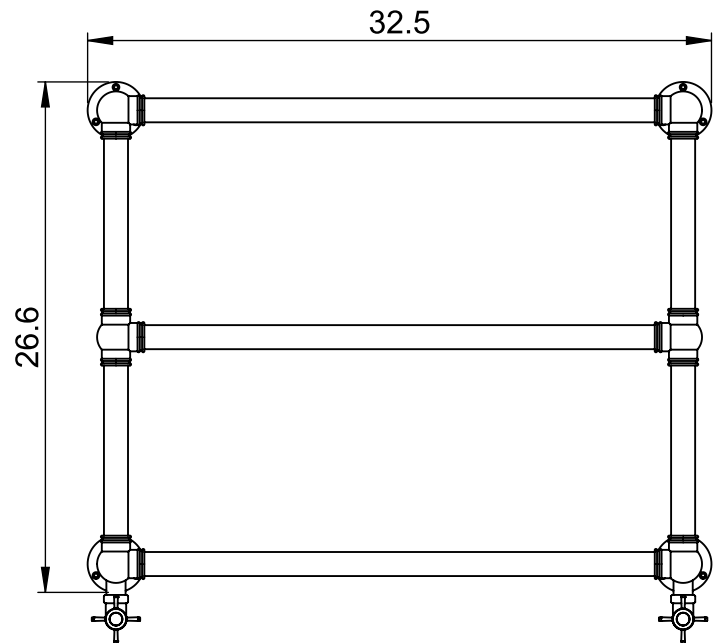
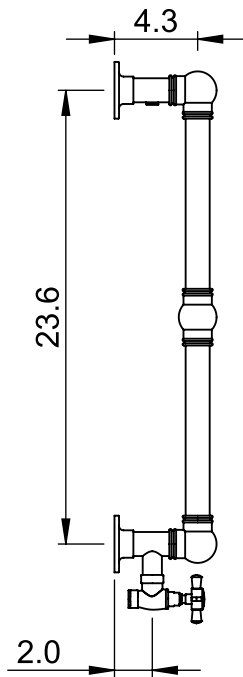
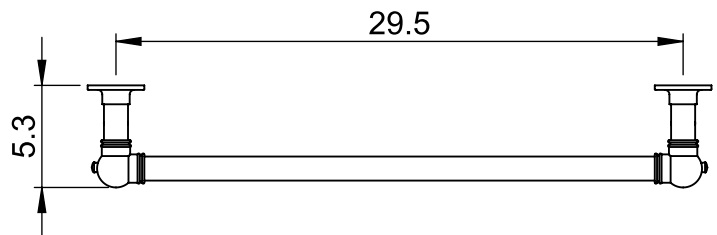

inches	mm
26.6	675
32.5	825
5.3	135
23.6	600
29.5	750
4.3	110
2.0	50

Vogue UK Ltd. reserve the right to alter specifications without prior notice.
 ALL MEASUREMENTS ARE NOMINAL DIMENSIONS ONLY, AND ARE NOT BINDING.



SCALE 1:10

VOGUE

TOWEL DRYERS

175 Memorial Drive Unit C
 Shrewsbury MA 01545 USA
 Tel: 508 887 8771 Fax: 508 887 8774
 e-mail: info@vogueuk.com www.vogueuk.com