

OG002C

26.6x32.5

Height: 26.6
 Width: 32.5
 Depth: 5.3
 Weight HO: lbs (kg)
 EO: lbs (kg)

Tube ϕ : 1.25
 Output @ 50°C Δ T: n/a
 Elec. element if specified: 125
 Pipe Centres: n/a

All dimensions in inches

Manufactured from ISO/CEN CuZn36As (BS CZ126) brass tube

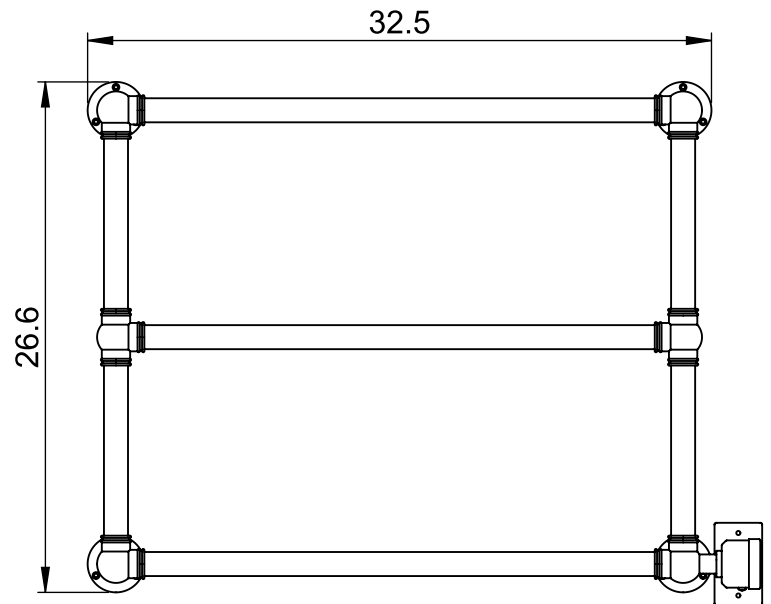
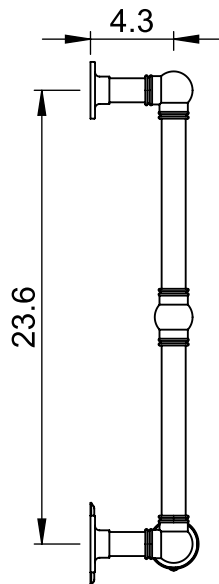
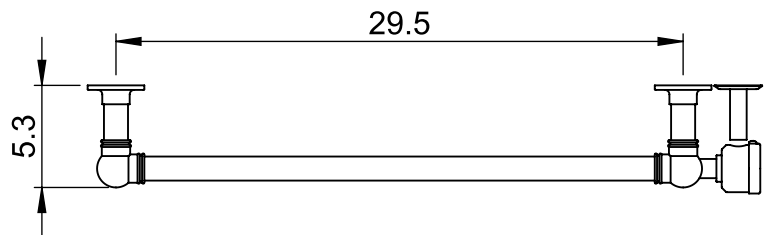
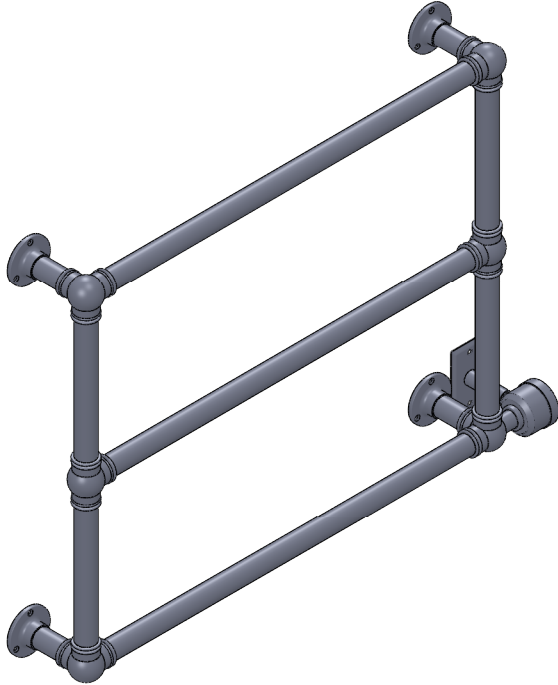

inches	mm
26.6	675
32.5	825
5.3	135
23.6	600
29.5	750
4.3	110

Vogue UK Ltd. reserve the right to alter specifications without prior notice.
 ALL MEASUREMENTS ARE NOMINAL DIMENSIONS ONLY, AND ARE NOT BINDING.



SCALE 1:10

VOGUE

TOWEL DRYERS

175 Memorial Drive Unit C
 Shrewsbury MA 01545 USA
 Tel: 508 887 8771 Fax: 508 887 8774
 e-mail: info@vogueuk.com www.vogueuk.com