

MD044 17.7x20.5

Height: 17.7
Width: 20.5
Depth: 5.1
Weight HO: lbs (kg)
EO: lbs (kg)

Tube ϕ : 1.25 + 0.9
Output @ 50° C Δ T: 214
Elec. element if specified: n/a
Pipe Centres: 19.2

All dimensions in inches

Manufactured from 1.4301/X5CrNi18-10 stainless steel

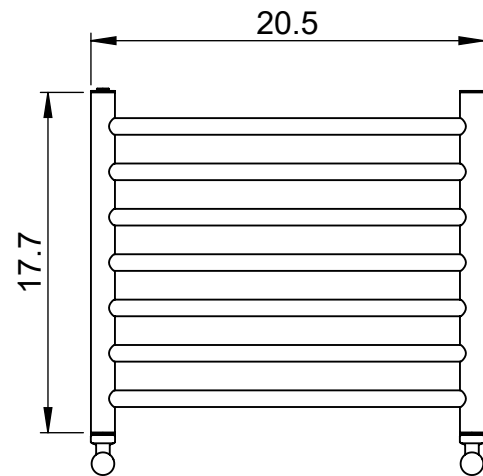
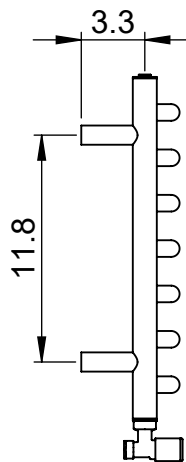
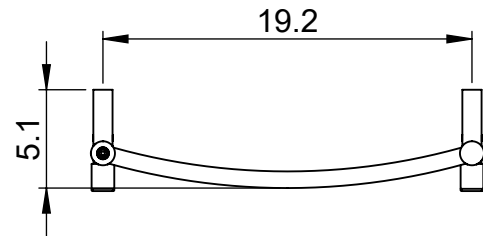
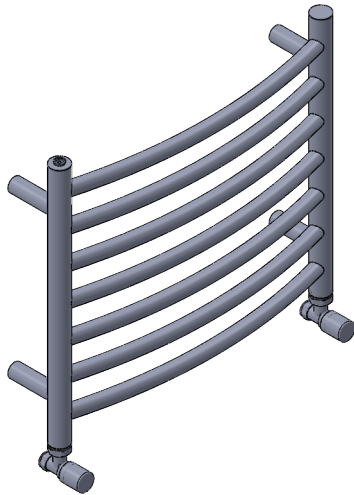

inches	mm
17.7	450
20.5	520
5.1	130
11.8	300
19.2	488
3.3	84

Vogue UK Ltd. reserve the right to alter specifications without prior notice.
ALL MEASUREMENTS ARE NOMINAL DIMENSIONS ONLY, AND ARE NOT BINDING.



SCALE 1:10

VOGUE
TOWEL DRYERS

175 Memorial Drive Unit C
Shrewsbury MA 01545 USA
Tel: 508 887 8771 Fax: 508 887 8774
e-mail: info@vogueuk.com www.vogueuk.com