

### MODEL RS 661

UNDERMOUNT TYPE

#### GENERAL

Fine quality sink bowl formed of 16 gauge  
BA 304 18/10 nickel bearing stainless steel.

#### DESIGN FEATURES

Bowl Depth : 10"  
Finish : Soft Satin Finish  
Underside : Sound absorbing pads and special paint  
applied to dampen sound  
Drain Opening : 3-1/2"



#### OPTIONAL ACCESSORIES

Stainless Steel Bottom Grid  
Wood Cutting Board  
Glass Cutting Board  
Stainless Steel Colander  
Drying Rack

#### SINK DIMENSIONS (INCHES)

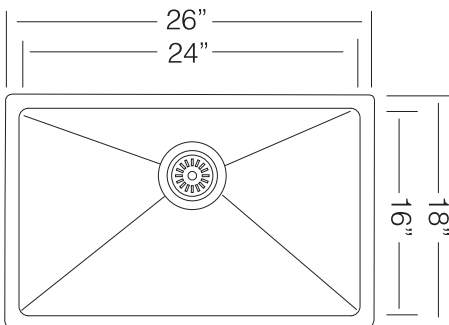

Recommended Cabinet Size 30"

#### INSTALLATION PROFILE\*

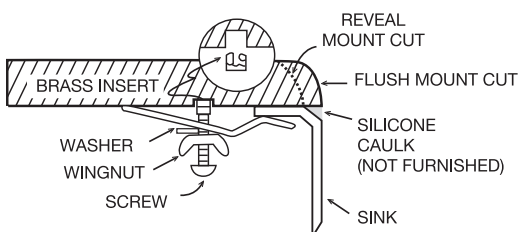

\*Template and countertop mounting clips are packed with every sink

Ukinox reserves the right to change product specifications without notice.  
Printed in USA © 2019 Ukinox

