



## Faucet: FL11-XX

### SPECIFICATION

- MADE OF SOLID BRASS
- CERAMIC CARTRIDGE
- FEMALE 3/8IN CONNECTION
- ADJUSTABLE ANTI-LIMESTONE SILICONE AERATOR (IMAGE A)

### AVAILABLE OPTION

- N/D

### AVAILABLE FINISH

- CHROME

### CONNECTION

- FEMALE 3/8IN CONNECTION

### FLOW RATE

- 5,7L/MIN [1.5 GPM] @60PSI

### WARRANTY

PRODUCTS COVERED BY A FULL LIMITED LIFETIME WARRANTY AGAINST ALL MANUFACTURING DEFECTS.

FOR MORE INFORMATION ABOUT THE PRODUCT, OR BEFORE PROCEEDING TO ANY INSTALLATION PLEASE CONSULT THE INSTALLATION MANUAL.



Intertek ASME 112.118.1 / CSA B125.1

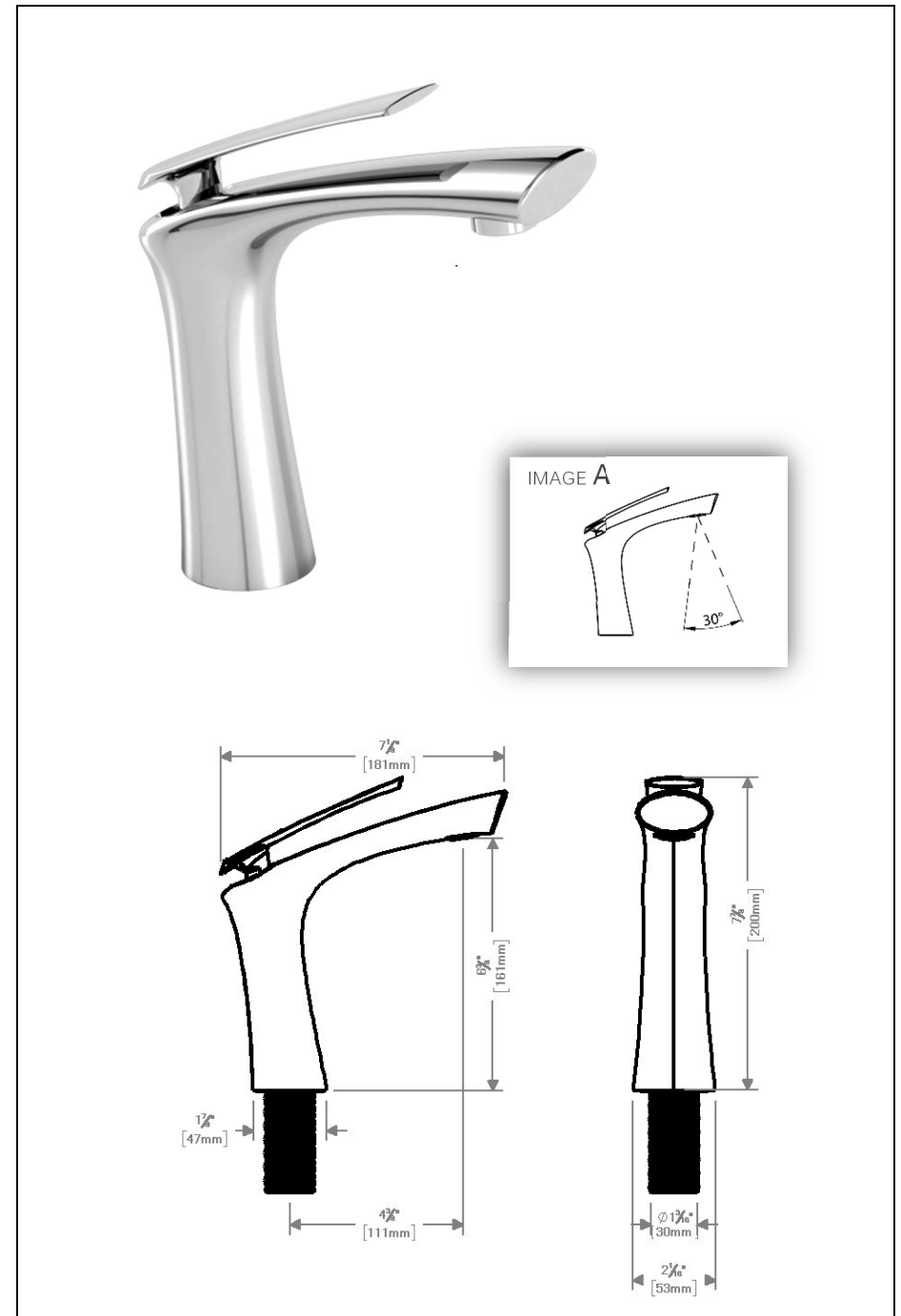

THE PRODUCT MAY VARY SLIGHTLY FROM ITS DIMENSION AND APPEARANCE.

EDITION : -2017-10-01