



T&S BRASS AND BRONZE WORKS, INC.
 2 Saddleback Cove / P.O. Box 1088
 Travelers Rest, SC 29690

Model No.
MPX-8DLN-08-CR

Item No.

Travelers Rest, SC: 800-476-4103 • Simi Valley, CA: 800-423-0150 • Fax: 864-834-3518 • www.tsbrass.com

This Space for Architect/Engineer Approval

Job Name _____ Date _____

Model Specified _____ Quantity _____

Customer/Wholesaler _____

Contractor _____

Architect/Engineer _____

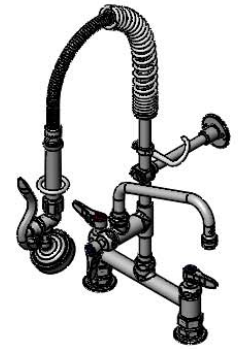
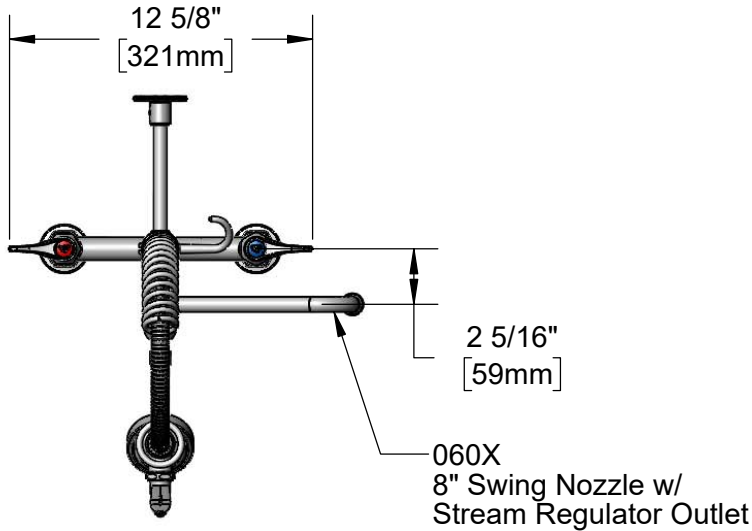

24" Flexible Stainless Steel
Hose w/ Spring & Spray
Valve

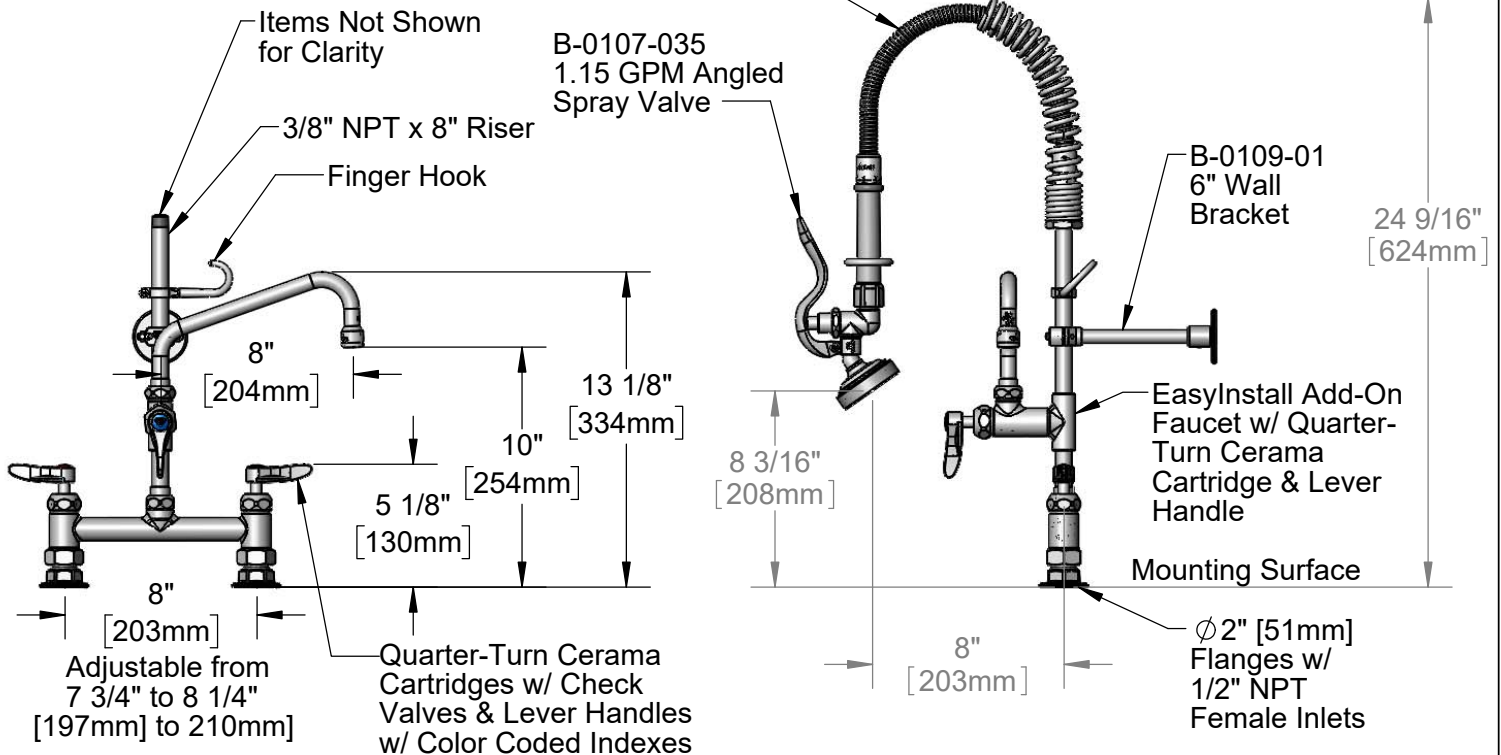

Product Specifications:

Pre-Rinse Unit: EasyInstall 8" Deck Mount Mixing Faucet, Quarter-Turn Cerama Cartridges w/ Check Valves, Lever Handles, Add-On Faucet w/ 8" Swing Nozzle, Compact Spring, 24" Flexible Stainless Steel Hose, 1.15 GPM Angled Spray Valve, 6" Wall Bracket & 1/2" NPT Female Inlets

Product Compliance:

ASME A112.18.1 / CSA B125.1
 NSF 61 - Section 9
 NSF 372 (Low Lead Content)
 2019 DOE PRSV - Class II
 For Commercial Use Only



T&S BRASS AND BRONZE WORKS, INC.

2 Saddleback Cove / P.O. Box 1088
Travelers Rest, SC 29690

Model No.

MPX-8DLN-08-CR

Item No.

Travelers Rest, SC: 800-476-4103 • Simi Valley, CA: 800-423-0150 • Fax: 864-834-3518 • www.tsbrass.com

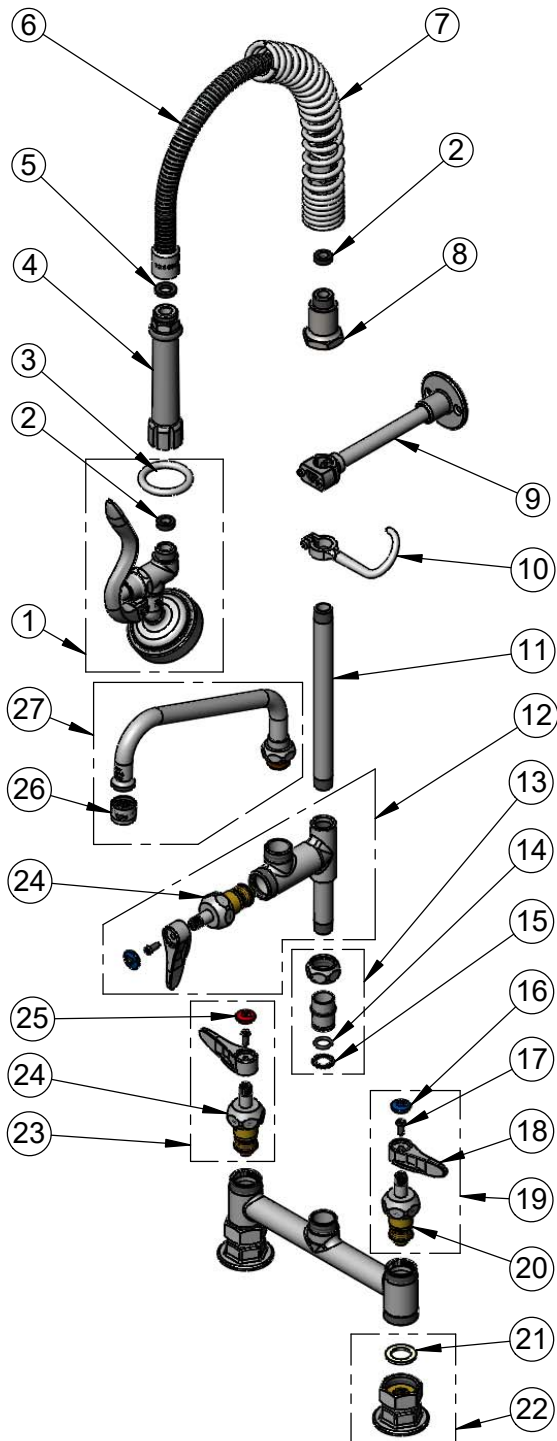

ITEM NO.	SALES NO.	DESCRIPTION
1	B-0107-035	1.15 GPM Angled Spray Valve
2	010476-45	#27 Washer
3	000907-45	Spray Valve Hold Down Ring
4	002987-40	Grip Handle
5	001014-45	Washer, B-0100 Hose Barrel
6	B-0024-H2A	24" Flexible Stainless Steel Hose, Less Handle
7	016795-45	Compact Spring
8	000821-40	Spring Body
9	B-0109-01	6" Wall Bracket
10	004R	Finger Hook
11	078X	3/8" NPT x 8" Riser
12	B-0155-CR-LN	EasyInstall Add-On Faucet, Cerama Cartridge & Lever Handle, Less Nozzle
13	EZ-K	EasyInstall Kit
14	006562-45	O-ring
15	014200-45	Star Washer, Anti-Rotation
16	018506-19NS	Blue Button Index, Press-in
17	000925-45	Lab Handle Screw
18	001638-45NS	Lever Handle (New Style)
19	012447-25NS	Quarter-Turn Cerama Cartridge w/ Check Valve, Handle, Blue Index & Screw, LTC
20	012395-25NS	Quarter-Turn Cerama Cartridge w/ Check Valve, LTC
21	001019-45	Coupling Nut Washer
22	00AA	1/2" NPT Female Eccentric Flange
23	012446-25NS	Quarter-Turn Cerama Cartridge w/ Check Valve, Handle, Red Index & Screw, RTC
24	012394-25NS	Quarter-Turn Cerama Cartridge w/ Check Valve, RTC
25	001193-19NS	Red Button Index, Press-in
26	B-PT	Full Flow Stream Regulator, 55/64-27
27	060X	8" Swing Nozzle

Product Specifications:

Pre-Rinse Unit: EasyInstall 8" Deck Mount Mixing Faucet, Quarter-Turn Cerama Cartridges w/ Check Valves, Lever Handles, Add-On Faucet w/ 8" Swing Nozzle, Compact Spring, 24" Flexible Stainless Steel Hose, 1.15 GPM Angled Spray Valve, 6" Wall Bracket & 1/2" NPT Female Inlets

Product Compliance:

ASME A112.18.1 / CSA B125.1
NSF 61 - Section 9
NSF 372 (Low Lead Content)
2019 DOE PRSV - Class II
For Commercial Use Only