



T&S BRASS AND BRONZE WORKS, INC.

2 Saddleback Cove / P.O. Box 1088
Travelers Rest, SC 29690

Model No.

B-0712-AM

Item No.

Travelers Rest, SC: 800-476-4103 • Simi Valley, CA: 800-423-0150 • Fax: 864-834-3518 • www.tsbrass.com



ADA Compliant

This Space for Architect/Engineer Approval

Job Name _____ Date _____

Model Specified _____ Quantity _____

Customer/Wholesaler _____

Contractor _____

Architect/Engineer _____

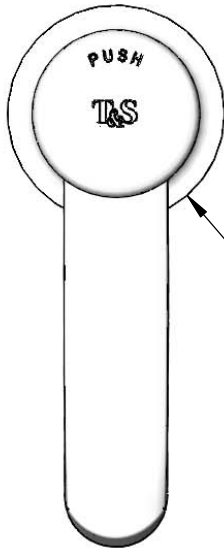

Ø 2 1/4"
[57mm]
Base

Spanner Bit for Access to
Metering Adjustment (Included)
(Metering Adjustment
Requires 3/32" Hex Key)

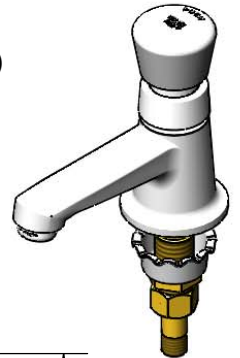

Push Button Cap
w/ Anti-Microbial
Coating

Push Button
Metering Cartridge

B-0199-03
2.2 GPM Aerator

1 5/16"
[34mm]

Mounting
Surface

2 5/16"
[59mm]

1/2" NPSM
Male Inlet

4 11/16"
[119mm]

4 1/16"
[103mm]

13/16"
[21mm]
Maximum
Thickness

150A
Optional Tailpiece & Nut
For 1/4" NPT Connection
(Included)

Rough-In Requirement:
Ø 1 1/8" [29mm] Mounting Hole

Product Specifications:

Single Hole Single Temperature Deck Mount Basin Faucet, Push Button
Metering Cartridge, Push Button Cap w/ Anti-Microbial Coating, 2.2 GPM
Aerator & 1/2" NPSM Male Inlet

Product Compliance:

ASME A112.18.1 / CSA B125.1
NSF 61 - Section 9
NSF 372 (Low Lead Content)
ANSI A117.1 (ADA)



T&S BRASS AND BRONZE WORKS, INC.
 2 Saddleback Cove / P.O. Box 1088
 Travelers Rest, SC 29690

Model No.
B-0712-AM

Item No.

Travelers Rest, SC: 800-476-4103 • Simi Valley, CA: 800-423-0150 • Fax: 864-834-3518 • www.tsbrass.com

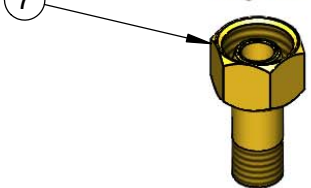
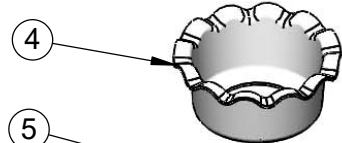
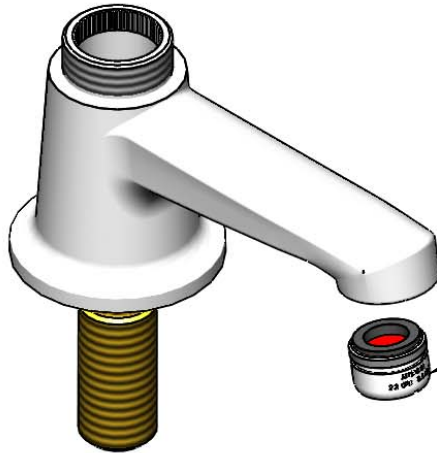
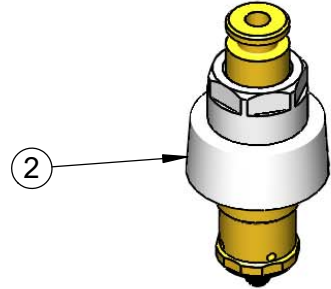
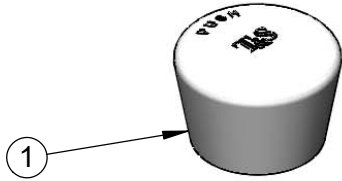

ITEM NO.	SALES NO.	DESCRIPTION
1	014193-40AM	Blank Push Button Cap w/ Anti-Microbial Coating & Spanner Bit
2	238A	Push Button Metering Cartridge
3	B-0199-03	2.2 GPM Aerator
4	001000-45	Rosette Washer
5	002954-45	Shank Lock Nut
6	150A	1/4" NPT Tailpiece & Nut
7	014734-45	Spanner Bit, #8

Product Specifications:

Single Hole Single Temperature Deck Mount Basin Faucet, Push Button Metering Cartridge, Push Button Cap w/ Anti-Microbial Coating, 2.2 GPM Aerator & 1/2" NPSM Male Inlet

Product Compliance:

ASME A112.18.1 / CSA B125.1
 NSF 61 - Section 9
 NSF 372 (Low Lead Content)
 ANSI A117.1 (ADA)