



T&S BRASS AND BRONZE WORKS, INC.

2 Saddleback Cove / P.O. Box 1088
Travelers Rest, SC 29690

Model No.

B-0122

Item No.

Travelers Rest, SC: 800-476-4103 • Simi Valley, CA: 800-423-0150 • Fax: 864-834-3518 • www.tsbrass.com

This Space for Architect/Engineer Approval

Job Name _____ Date _____

Model Specified _____ Quantity _____

Customer/Wholesaler _____

Contractor _____

Architect/Engineer _____

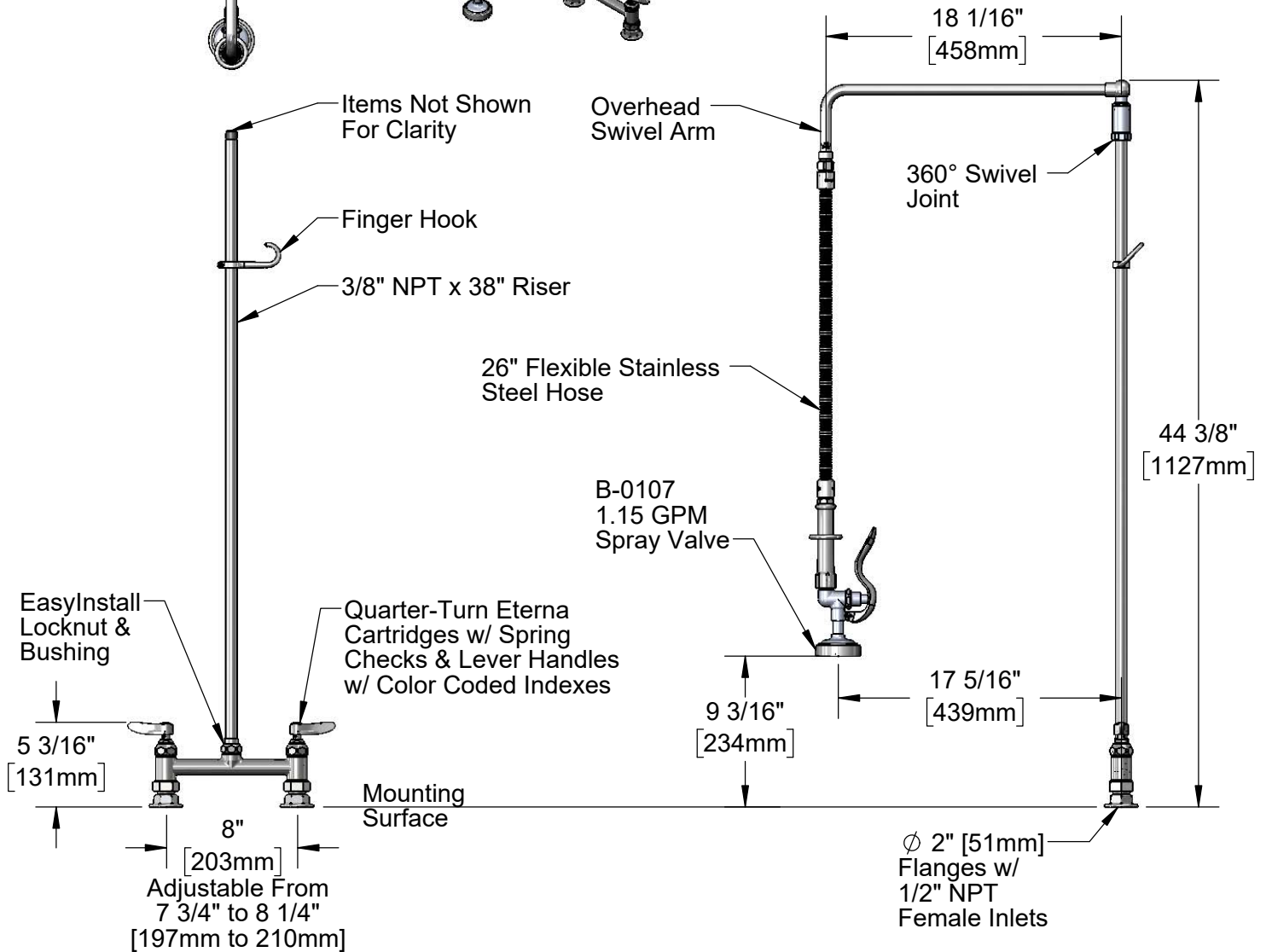
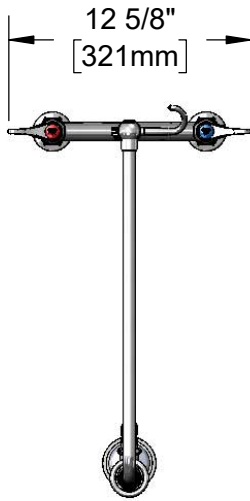

Product Specifications:

Pre-Rinse Unit: 8" Deck Mount Mixing Faucet, Quarter-Turn Eterna Cartridges w/ Spring Checks, Lever Handles, 1.15 GPM Spray Valve, 38" Riser, 18 1/16" Overhead Swivel Arm & 1/2" NPT Female Inlets

Product Compliance:

ASME A112.18.1 / CSA B125.1
NSF 61 - Section 9
NSF 372 (Low Lead Content)
2019 DOE PRSV - Class II



T&S BRASS AND BRONZE WORKS, INC.

2 Saddleback Cove / P.O. Box 1088
Travelers Rest, SC 29690

Model No.

B-0122

Item No.

Travelers Rest, SC: 800-476-4103 • Simi Valley, CA: 800-423-0150 • Fax: 864-834-3518 • www.tsbrass.com

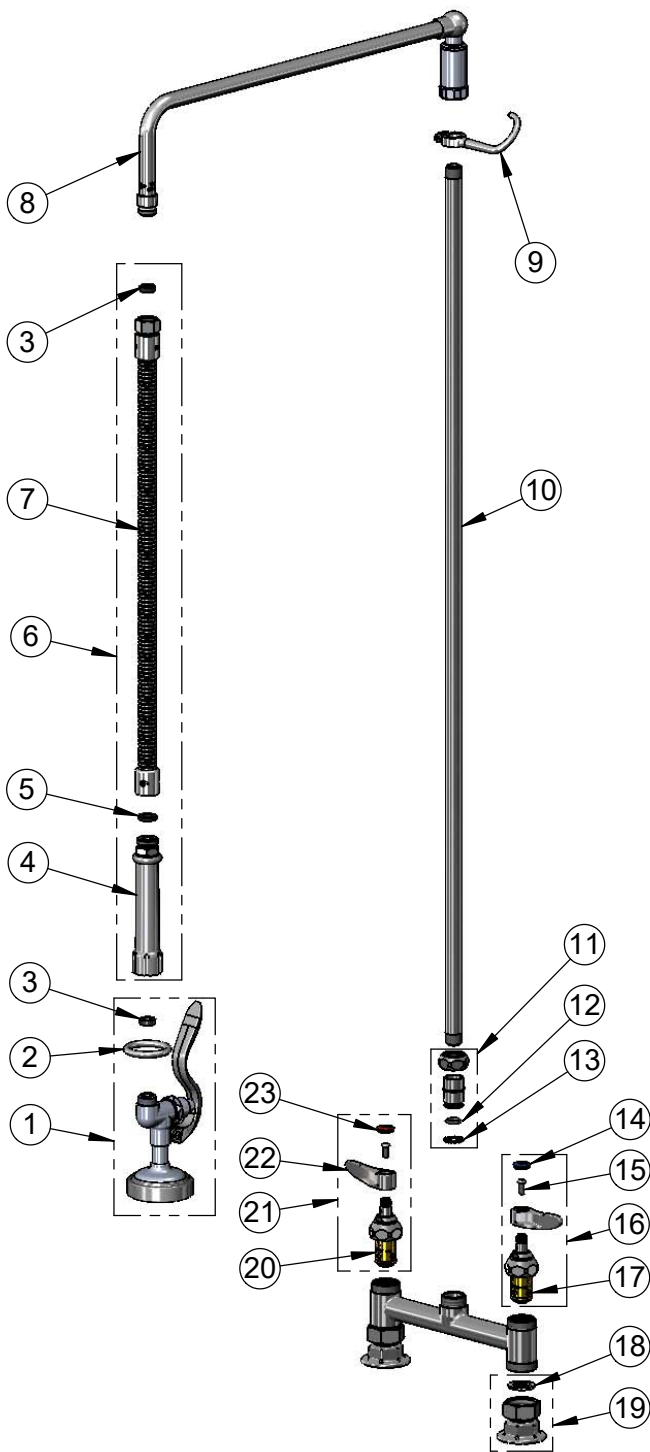

ITEM NO.	SALES NO.	DESCRIPTION
1	B-0107	1.15 GPM Spray Valve
2	000907-45	Spray Valve Hold Down Ring
3	010476-45	#27 Washer
4	002987-40	Grip Handle
5	001014-45	Washer, B-0100 Hose Barrel
6	B-0026-H	26" Flexible Stainless Steel Hose
7	B-0026-H2A	26" Flexible Stainless Steel Hose Less Handle
8	002883-40	18" Swivel L-Tube
9	004R	Finger Hook
10	000377-40	3/8" NPT x 38" Riser
11	EZ-K	EasyInstall Kit
12	001065-45	O-ring
13	014200-45	Star Washer, Anti-Rotation
14	018506-19NS	Blue Button Index, Press-in
15	000925-45	Lab Handle Screw
16	002711-40NS	Quarter-Turn Eterna Cartridge w/ Spring Check, Handle, Blue Index & Screw, LTC
17	012442-40NS	Quarter-Turn Eterna Cartridge w/ Spring Check, LTC
18	001019-45	Coupling Nut Washer
19	00AA	1/2" NPT Female Eccentric Flange
20	012443-40NS	Quarter-Turn Eterna Cartridge w/ Spring Check, RTC
21	002712-40NS	Quarter-Turn Eterna Cartridge w/ Spring Check, Handle, Red Index & Screw, RTC
22	001638-45NS	Lever Handle (New Style)
23	001193-19NS	Red Button Index, Press-in

Product Specifications:

Pre-Rinse Unit: 8" Deck Mount Mixing Faucet, Quarter-Turn Eterna Cartridges w/ Spring Checks, Lever Handles, 1.15 GPM Spray Valve, 38" Riser, 18 1/16" Overhead Swivel Arm & 1/2" NPT Female Inlets

Product Compliance:

ASME A112.18.1 / CSA B125.1
NSF 61 - Section 9
NSF 372 (Low Lead Content)
2019 DOE PRSV - Class II