

Features

- Micro Dual mount installation. Sink can be installed under counter mounted or top mounted where the rim of the sink sits on the counter top. Sink has a thin 2mm edge when installed as top mount.
- 33" (838) x 22" (559) x 10" (254) kitchen sink.
- Double equal compartments.
- Handcrafted from 16 gauge 304 stainless steel. Channel grooves in sink bottom direct water to drain. Premium brushed finish.
- Low 6" (152) high divide.
- Includes 2 stainless steel bottom sink grids, stainless covered flip-top sink and disposer strainers.
- 3/8" (10mm) radius corners.
- 5mm sound deadening pads.
- Fits 36" (914) minimum base cabinet width.

Components

- Product includes:
- TSG32182 Bottom Sink Grid Set
 - 2210R Covered Sink Strainer
 - 4010 Covered Disposer Strainer
 - Cutout Template
 - Installation Hardware
 - Installation Instructions

Warranty

- Lifetime Limited Warranty



Specified Model

Model	DTDE332210
Overall Dimensions	L33" x W22" x D10" 838 x 559 x 254
Bowl Dimensions (Left)	L14 ³ / ₄ " x W16 ³ / ₄ " x D10" 375 x 425 x 254
Bowl Dimensions (Right)	L14 ³ / ₄ " x W16 ³ / ₄ " x D10" 375 x 425 x 254
Drain holes:	3 ⁵ / ₈ " (92mm)
Shipping Weight	30 lbs.
Material	16 gauge 304 stainless steel
Installation	top or under counter mounted
Required	template, included

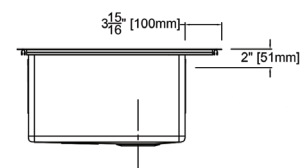
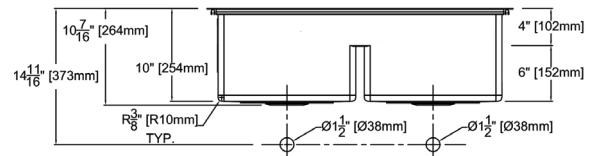
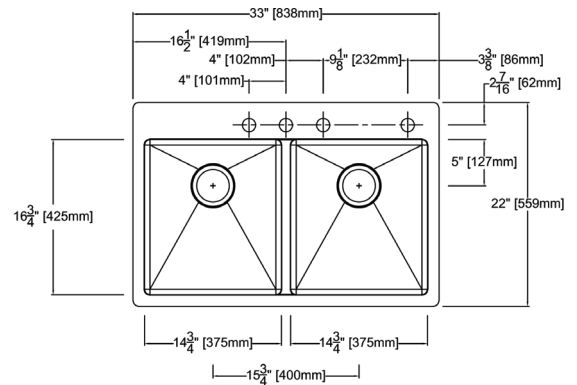

To Be Specified:

see back for configurations available for this sink

Faucet Hole Drillings	
<input type="checkbox"/>	1 Hole
<input type="checkbox"/>	2 Holes - FR2
<input type="checkbox"/>	2 Holes - MR2
<input type="checkbox"/>	3 Holes
<input type="checkbox"/>	4 Holes
<input type="checkbox"/>	5 Holes

Codes/Standards

ASME A112.19.3/CSA B45.4

Notes

Install this product according to the installation instructions.

Faucet Hole Configurations available for this sink model

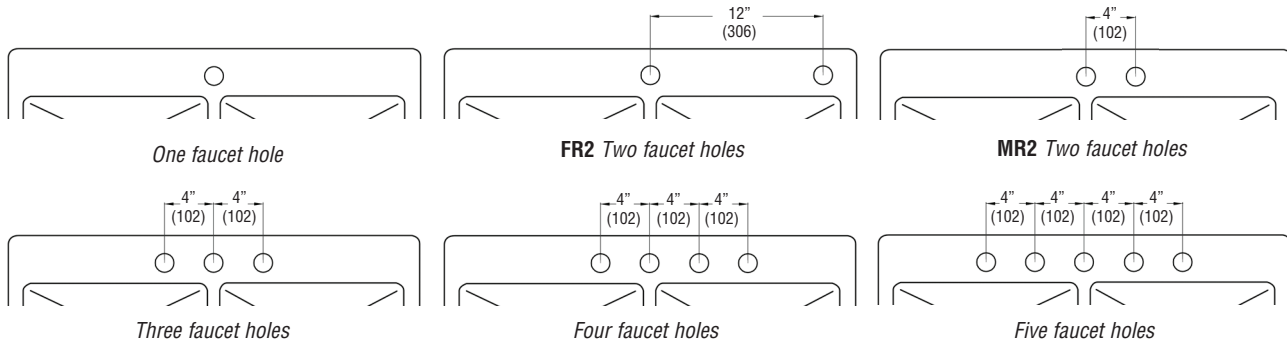

Components

Product includes:

TSG32182 Bottom Sink Grid Set

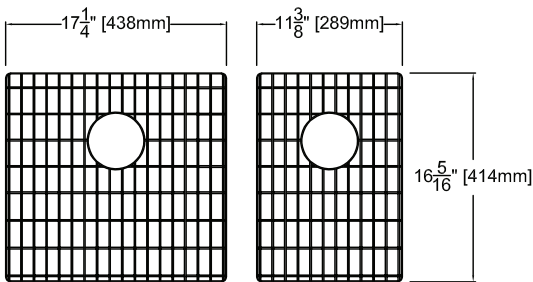

2210R Covered Flip Top Sink Strainer.

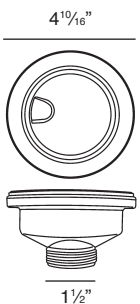

Water drains easily when cover is in place. Cover flips up with easy touch. Polypropylene housing. Fits standard 3 1/2" opening.

Optional Remote Covered Strainer 2310 is available. See Accessories to order.

4010 Covered Flip Top Disposer Strainer.

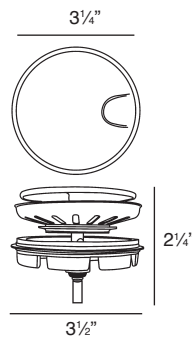

Water drains easily when cover is in place. Cover flips up with easy touch. Polypropylene housing. Top mount installation for 3 1/2" opening.