



Faucet: SL51-CR

SPECIFICATION

- MADE OF SOLID BRASS
- CERAMIC CARTRIDGE
- FEMALE 1/2IN CONNECTION
- PUSH-BUTTON DIVERTER

AVAILABLE OPTION

- N/D

AVAILABLE FINISH

- CHROME

CONNECTION

- FEMALE 1/2IN CONNECTION

FLOW RATE

- SPOUT: 34 L/MIN [8.5 GPM] @60PSI
- HAND SHOWER : 9.5 L/MIN [2.5 GPM] @60 PSI

WARRANTY

PRODUCTS COVERED BY A FULL LIMITED LIFETIME WARRANTY AGAINST ALL MANUFACTURING DEFECTS.

FOR MORE INFORMATION ABOUT THE PRODUCT, OR BEFORE PROCEEDING TO ANY INSTALLATION PLEASE CONSULT THE INSTALLATION MANUAL.



Intertek ASME 112.118.1 / CSA B125.1

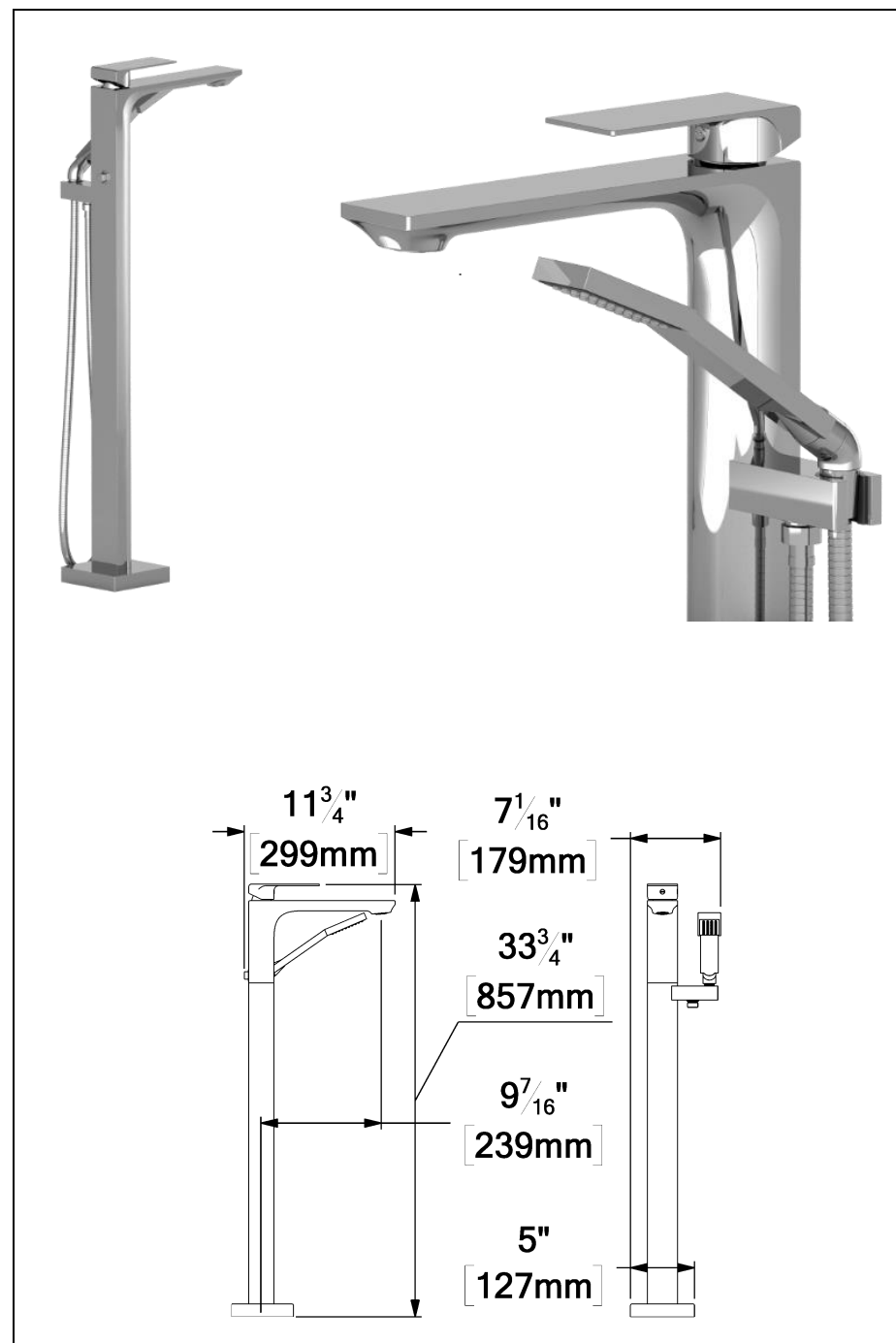

THE PRODUCT MAY VARY SLIGHTLY FROM ITS DIMENSION AND APPEARANCE.

EDITION : -2017-10-01