

BEYOND CRYSTAL - BLUE CRYSTAL

U6K-36/US

3/4" deck valve with trim

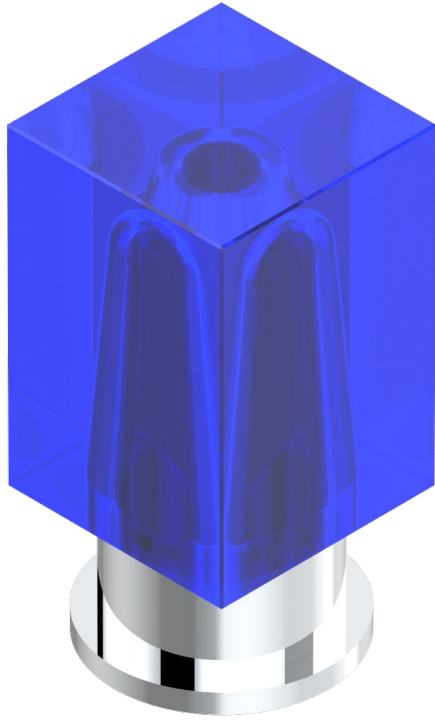

With Flange

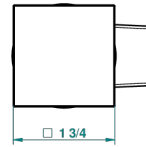
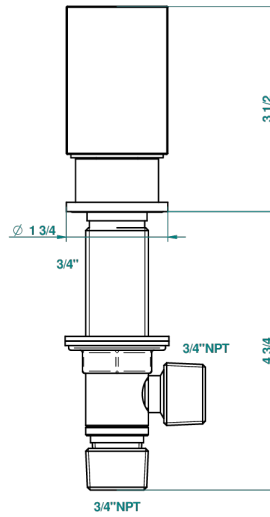

ø de perçage conseillé
recommended drilling ø
empfohlener Abstand
Ø de perforación aconsejado

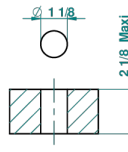

52180

Without Flange

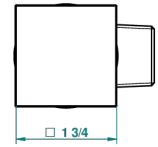
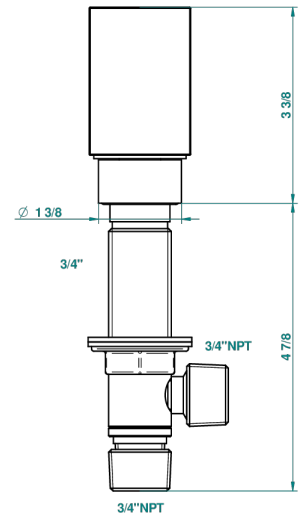

ø de perçage conseillé
recommended drilling ø
empfohlener Abstand
Ø de perforación aconsejado

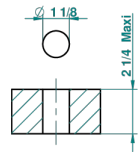

22/04/2014

CHARACTERISTIC

- ASME : ASME A112.18.1-2011/CSA B125.1-11

STANDARDS



AVAILABLE FINITIONS

Black nickel - D24

Blush PVD - H62

Brass color PVD - H49

Brown bronze color PVD - F33

Chrome polished - A02

Chrome polished / gold polished - G02

Gold color PVD - H52

Gold mat - F07

Gold polished - F01

Gold satiney - F03

Graphite PVD - H64

Matt Umber PVD - H67

Matt blush PVD - H60

Matt brass color PVD - H50

Matt brown bronze color PVD - F34

Matt chrome (American satin) - C02

Matt gold color PVD - H53

Matt graphite PVD - H65

Matt nickel color PVD - H56

Nickel antique / Sovereign - H28

Nickel color PVD - H55

Rose Gold - F27

Satin chrome - C03

Silver rhodium - F18

Soft gold - F30

Soft matt gold - F31

Umber PVD - H66