

INSTALLATION INSTRUCTIONS

Model # 72252

READ AND SAVE THESE INSTRUCTIONS

WARNING! SHUT POWER OFF AT FUSE OR CIRCUIT BREAKER.

AVERTISSEMENT! COUPER LE COURANT AU NIVEAU DES FUSIBLES OU DU DISJONCTEUR.

MOUNTING THE FIXTURE (Fig.1)

1. Shut off power at the circuit breaker and remove the old fixture including the mounting hardware.
2. Carefully unpack your new fixture and lay out all the parts in a clear area. Take care not to misplace any small parts necessary for installation.
3. Thread the two studs (B) into the pre-drilled holes in the circular strap (C) spaced the same distance apart as the holes in the back plate (H), and then tighten with the nut (E). The length of studs (B) into circular strap (C) may be adjusted if necessary.
4. Attach circular strap (C) using outlet box screws (F) to the outlet box (A), (Fig 1).

Fig. 1

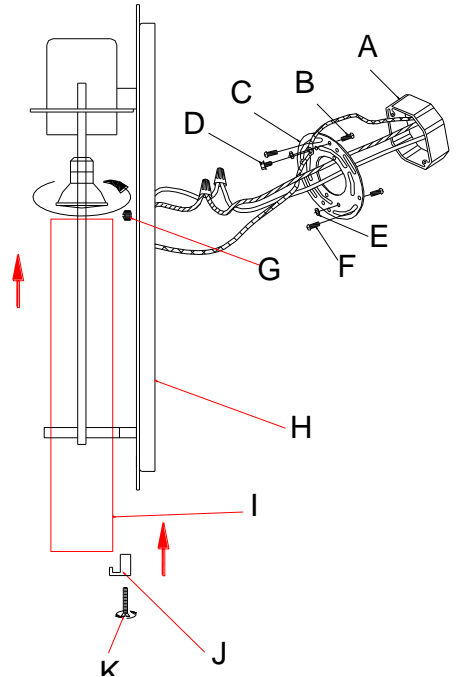

CONNECTING THE WIRES (Fig.2)

5. Connect the electrical wires as shown in Fig.2. Making sure that all wire connectors are secured. If your outlet box has a ground wire (green or bare copper), connect the fixture's ground wire to it. Otherwise, connect the fixture's ground wire directly to the circular strap using the green screw (D) provided.

COMPLETING THE INSTALLATION (Fig.1)

6. Align back plate (H) onto studs (B) and secure with cap nuts (G). (Fig 1)
7. To prevent moisture from entering the outlet box (A) and causing a short, use clear silicone Sealant to outline the outside of fixture back plate (H) where it meets the wall leaving a space at bottom to allow moisture a means to escape(Fig 3).
8. Install 1*35W/ GU10 Halogen bulb (two bulbs included) in accordance with the fixture specification. **DO NOT EXCEED THE MAXIMUM WATTAGE RATING! (NE PAS DEPASSER LA PUISSANCE NOMINALE MAXIMALE!)**
9. Remove screw (K) and tab (J), insert the glass (I) from the bottom, and then replace tab (J) and screw (K) to secure the glass.

Your installation is now complete. Return power to the outlet box and test the fixture.

IMPORTANT: FIXTURE SHOULD BE INSTALLED BY A QUALIFIED ELECTRICIAN TO ENSURE PROPER WIRING AND INSTALLATION.

ATTENTION – RISQUE D'INCENDIE. CONSULTER UN ÉLECTRICIEN QUALIFIÉ POUR VOUS ASSURER QUE LES CONDUCTEURS DE LA DÉRIVATION SONT ADÉQUATS.

