

DEADBOLTS

COMMERCIAL LOCKS - 32 SERIES
GRADE 2 DEADBOLT
BUILDER PACK

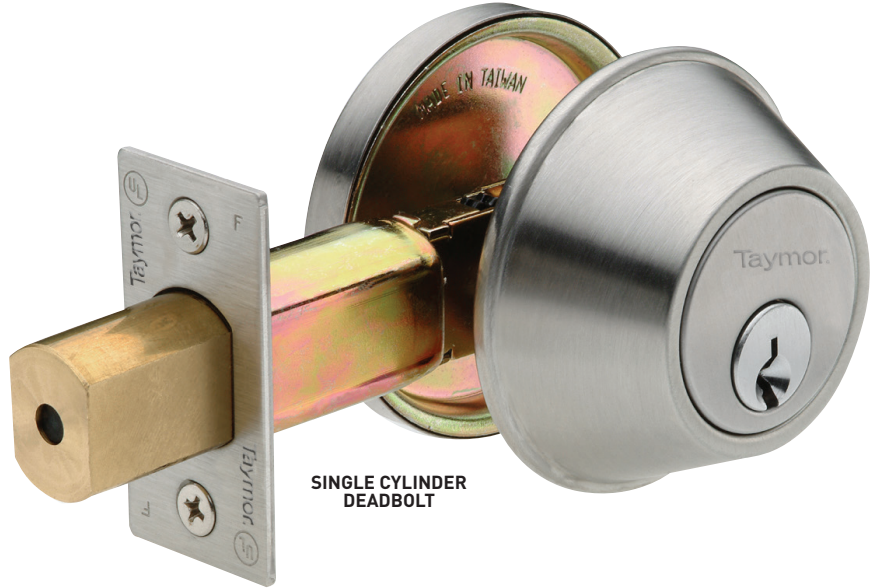
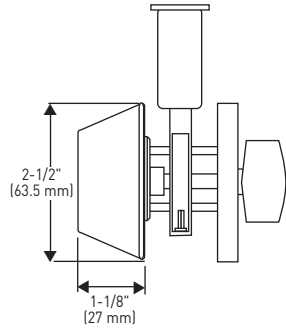

SINGLE CYLINDER DEADBOLT

AVAILABLE FINISHES

US3*
POLISHED BRASS



US26D
SATIN CHROME

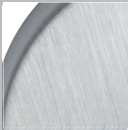

US26D/US32*
SATIN CHROME/ STAINLESS STEEL



US32*
STAINLESS STEEL

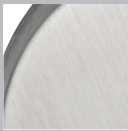

US32D*
SATIN STAINLESS STEEL

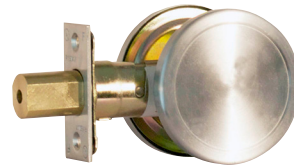
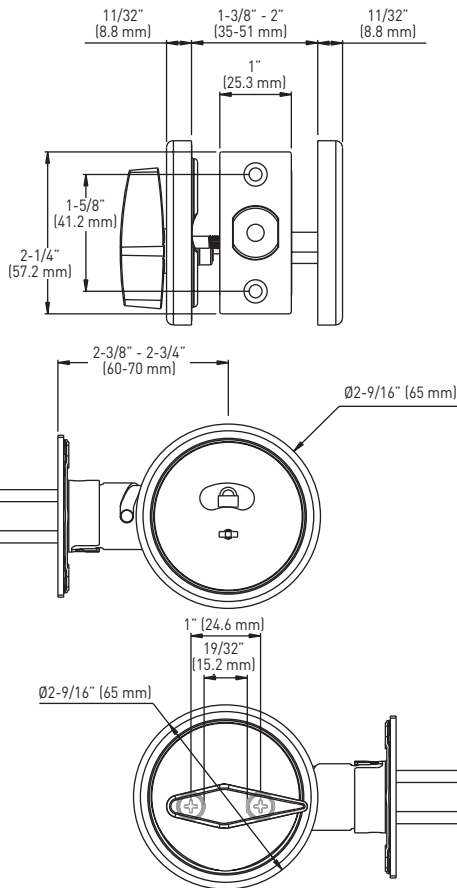
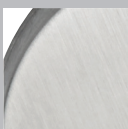

COMMUNICATING DEADBOLT



OCCUPANCY INDICATOR DEADBOLT SHOWING RED "LOCKED" & GREEN "UNLOCKED" ICONS

FEATURES

- MEETS OR EXCEEDS REQUIREMENTS OF BHMA/ANSI A 156.2 GRADE 2
- UL LISTED
- 3 HOUR FIRE RATED
- ISO 9002
- 6 PIN "C" KEYWAY - FULLY COMPATIBLE WITH SCHLAGE AND OTHER "C" KEYWAYS
- 2-3/4" (70mm) BACKSET SUPPLIED STANDARD FOR SINGLE CYLINDER DEADBOLT
- ADJUSTABLE BACKSET STANDARD FOR OCCUPANCY INDICATOR DEADBOLT
- WEISER KEYWAY OPTION AVAILABLE UPON REQUEST
- 5 YEAR MECHANICAL WARRANTY

SINGLE CYLINDER DEADBOLT - BUILDER PACK COMMERCIAL GRADE 2

	US3* POLISHED BRASS	US26D SATIN CHROME	US26D/C32* SATIN CHROME/ STAINLESS STEEL	US32* STAINLESS STEEL	US32D* SATIN STAINLESS STEEL	CASE PACK
SINGLE CYLINDER DEADBOLT	32-F460*	32-F470	32-F47040*	32-F440*	32-F450*	20
SINGLE SIDED COMMUNICATING DEADBOLT		32-F218				20
OCCUPANCY INDICATOR DEADBOLT		32-F238			32-F238SSS*	20

*SPECIAL ORDER - CONTACT YOUR SALES REPRESENTATIVE FOR DETAILS